

Pop Up Modular



ABC EXPO .BE

Portable and folding displays and stands
Layout, graphics, photography and digital printing



PopUp Modular

ideaal om zelf je gepersonaliseerde stand te bouwen. De configuratie kan je steeds zelf aanpassen!



- geen gereedschap
- compact en zeer licht
- makkelijk voor transport
- snel op te bouwen
- PopUp frame
- Textiel print met silicone pees



Canvas draagtas



Connectors



Voeten



Optie : Led Backlit



Verbinding stangen

MODU 100

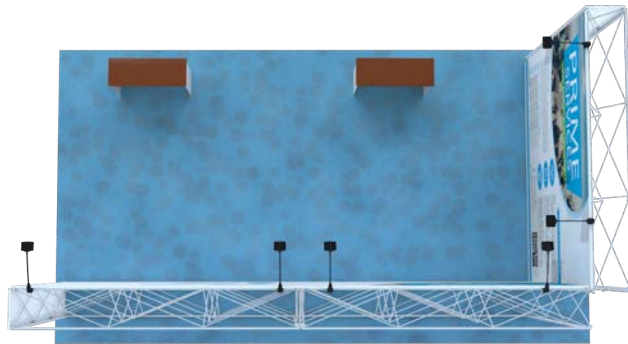
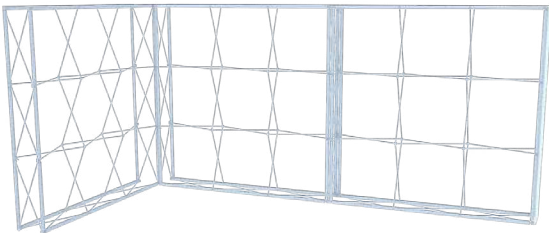

MODU 101

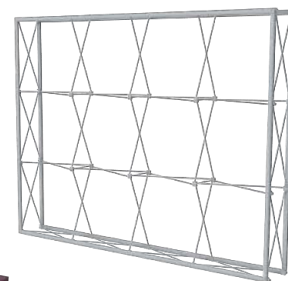

MODU 102

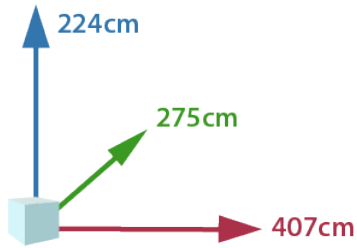
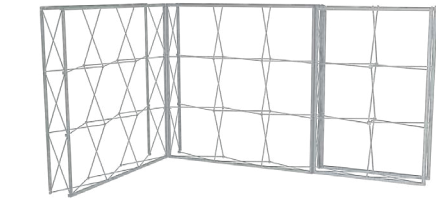

x 3 transport tassen



snel geïnstaleerd

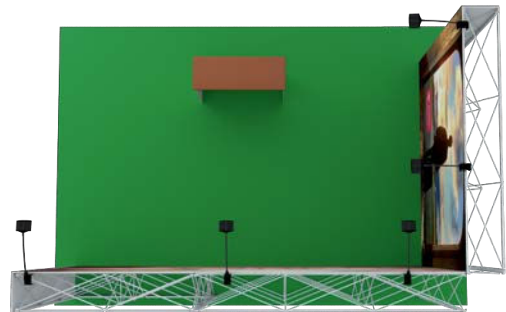

MODU 103

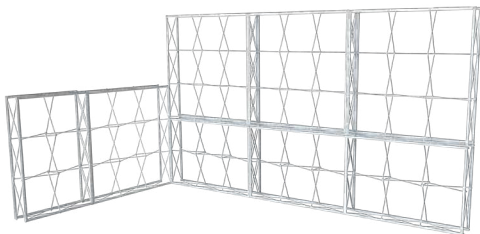
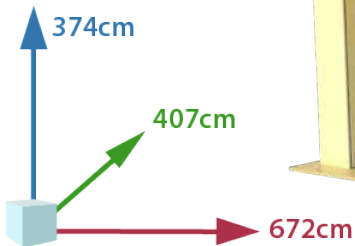

x 8 transport tassen



snel geïnstaleerd



MODU 104



- x 5 transport tassen
- snel geïnstalleerd

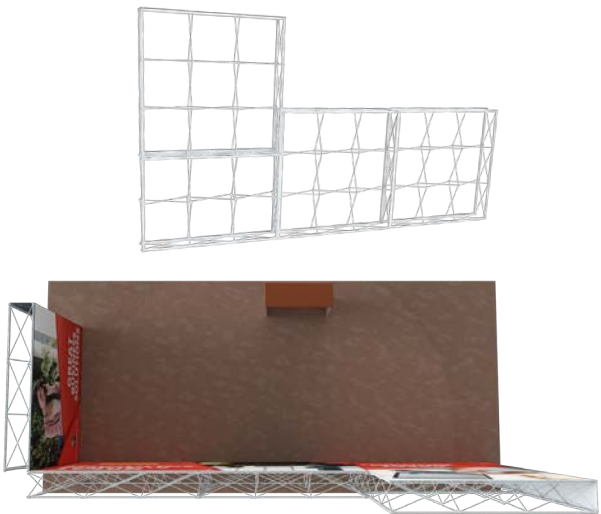

MODU 105

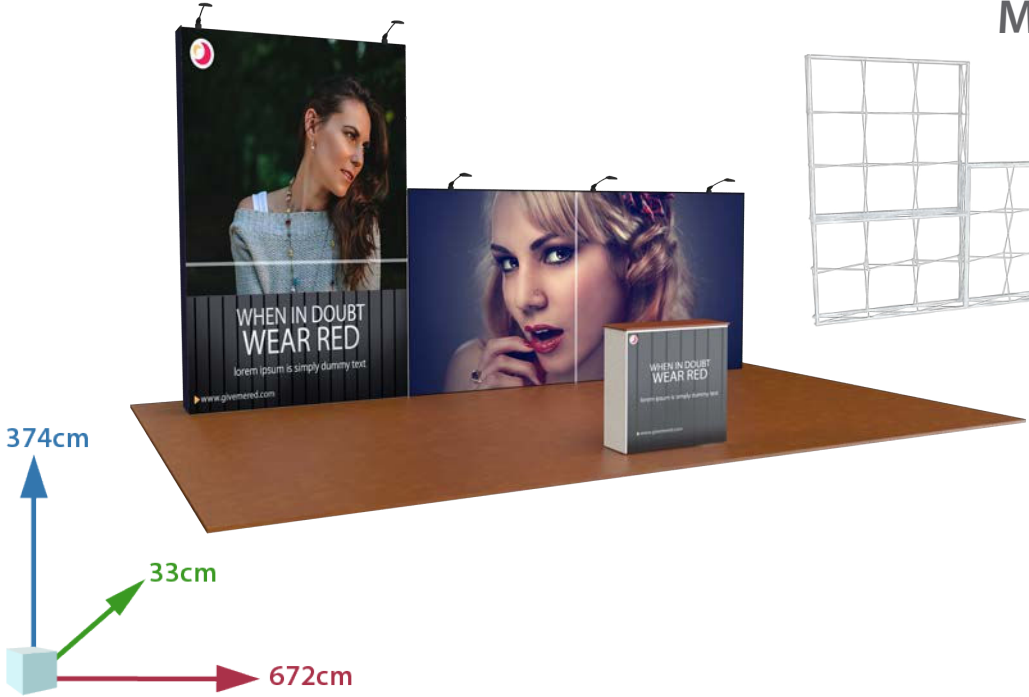

- x 4 transport tassen
- snel geïnstalleerd



MODU 106

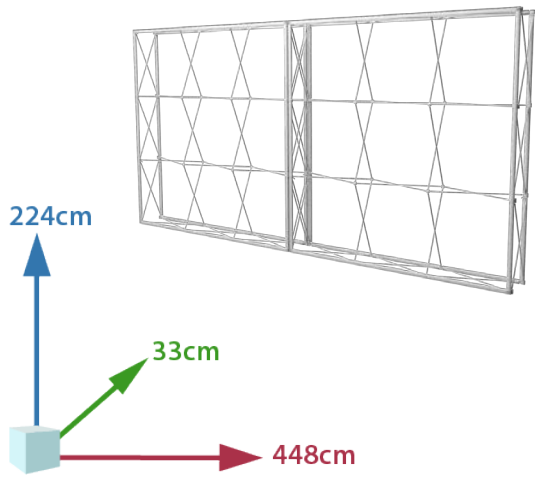

x 2 transport tassen



snel geïnstaleerd



MODU 107

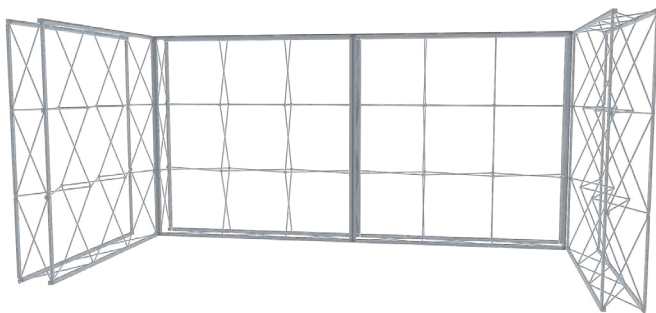
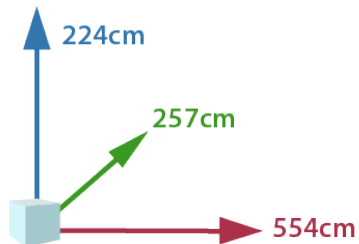

x 4 transport tassen



snel geïnstaleerd



MODU 108

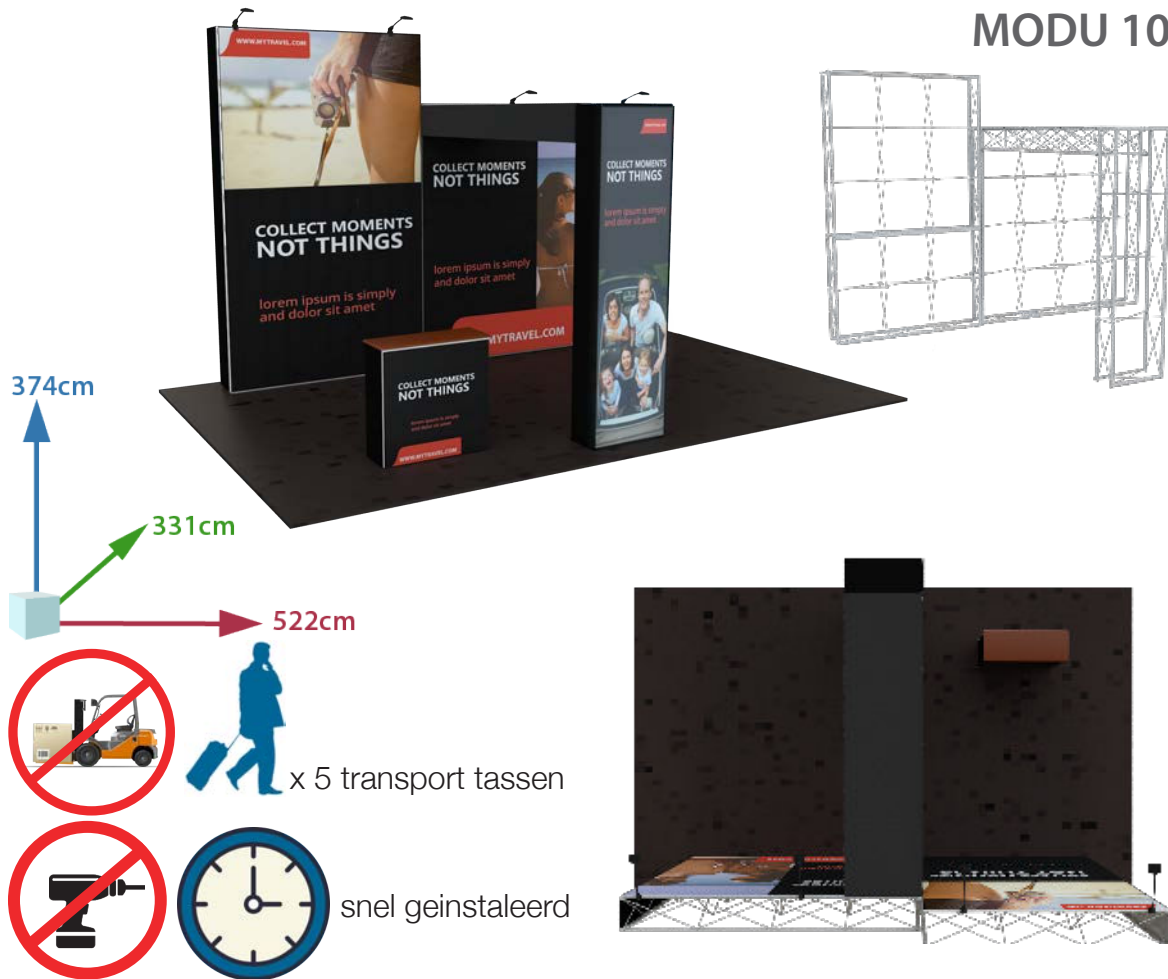

MODU 109



MODU 110

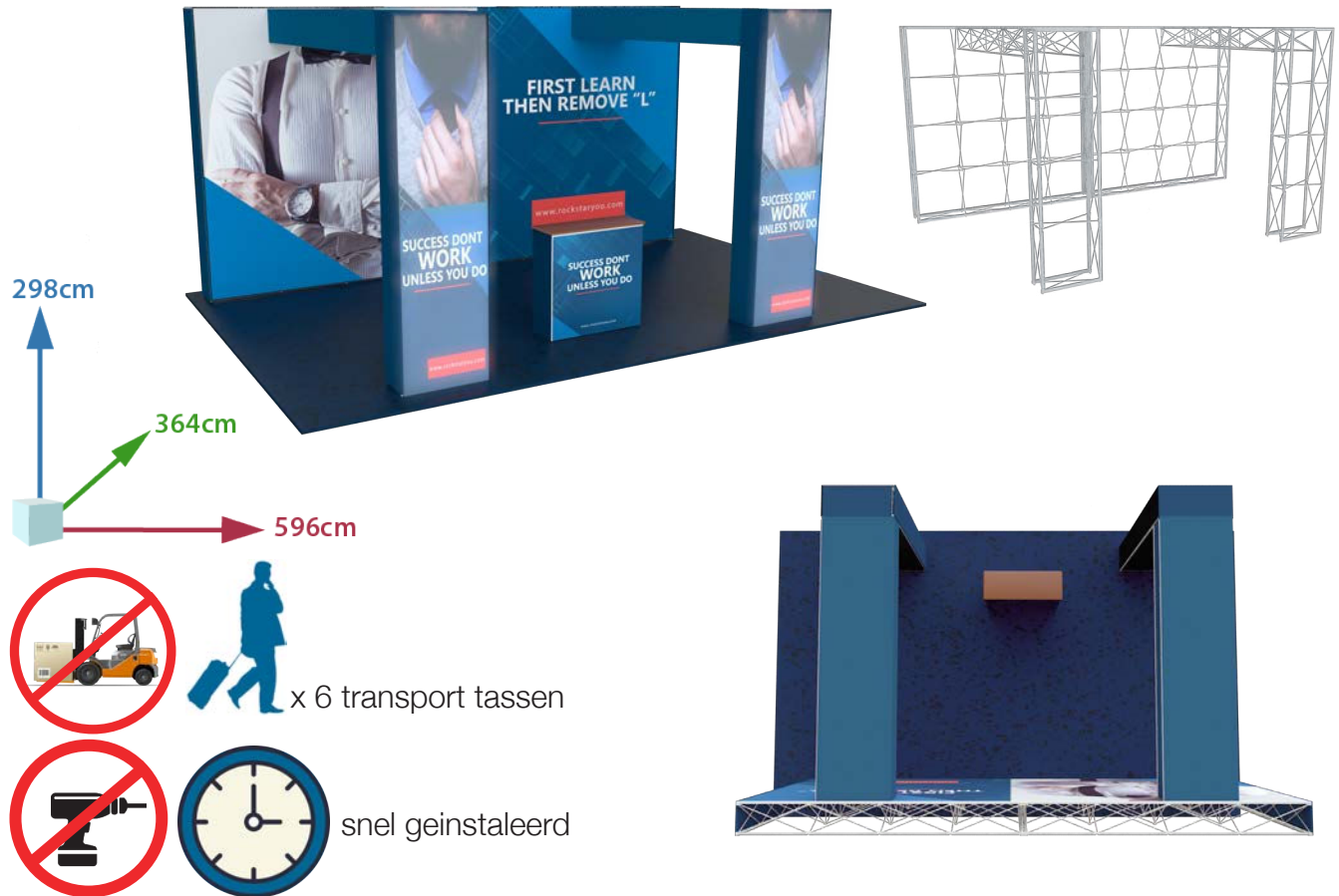

MODU 111

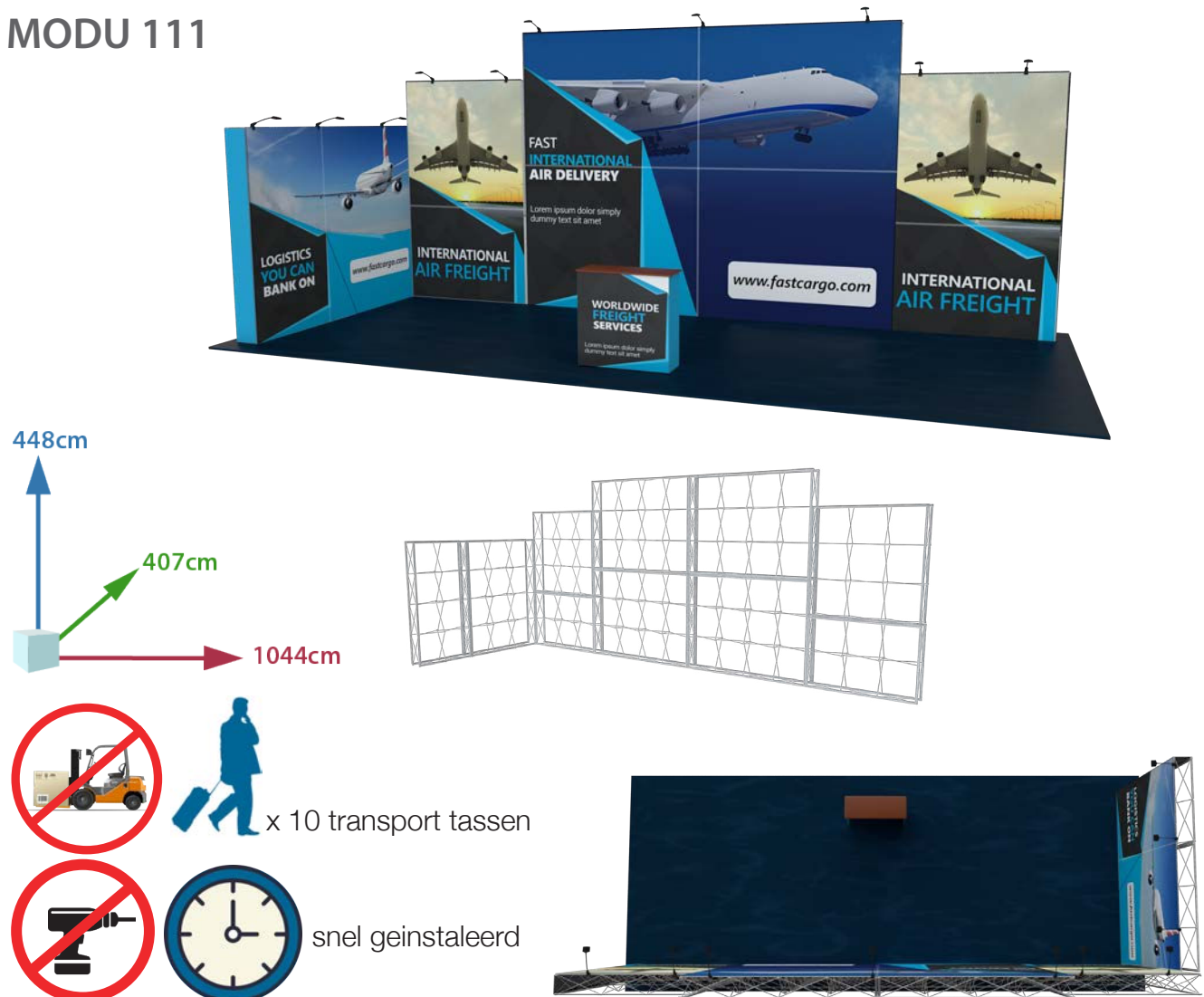

MODU 112

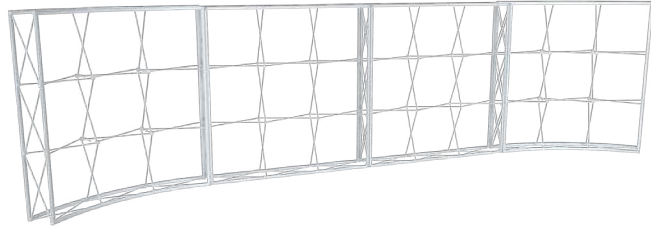
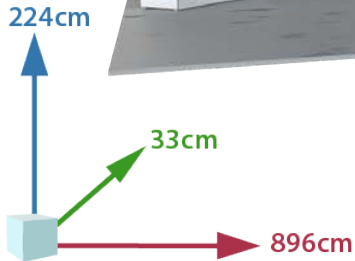

MODU 113

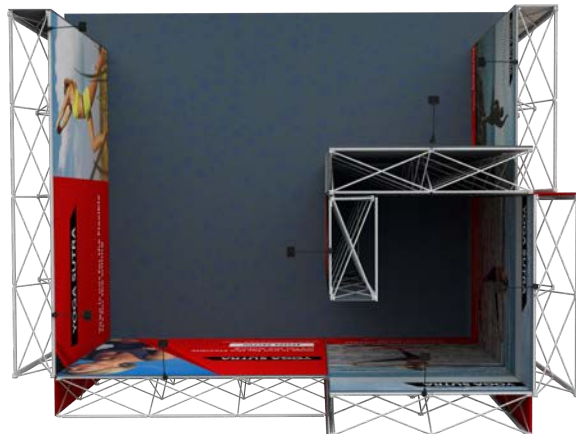
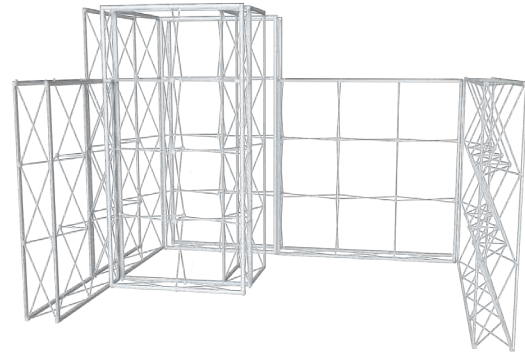
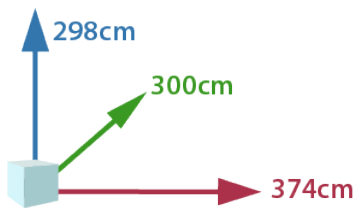

MODU 114



224cm



33cm



1192cm

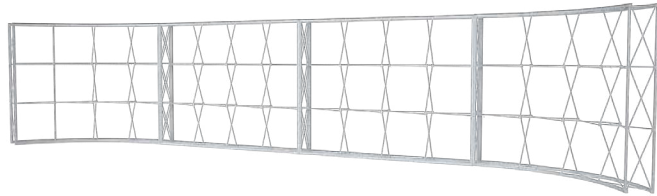

x 4 transport tassen



snel geïnstalleerd

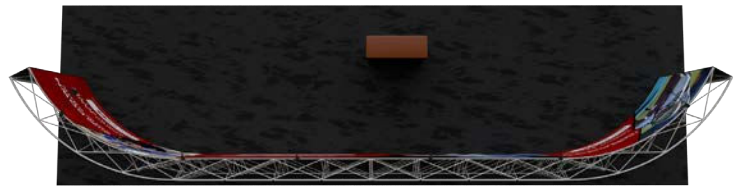

MODU 115



298cm



58,5cm



838cm

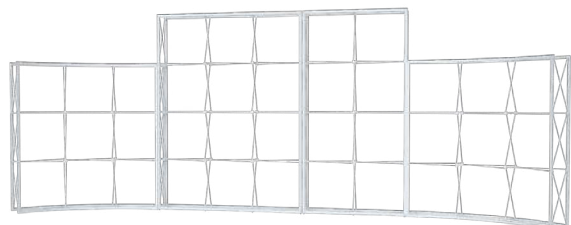

x 4 transport tassen



snel geïnstalleerd



MODU 116

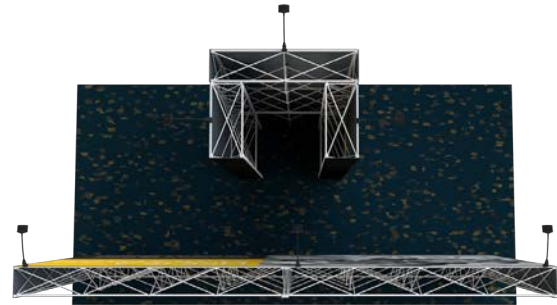
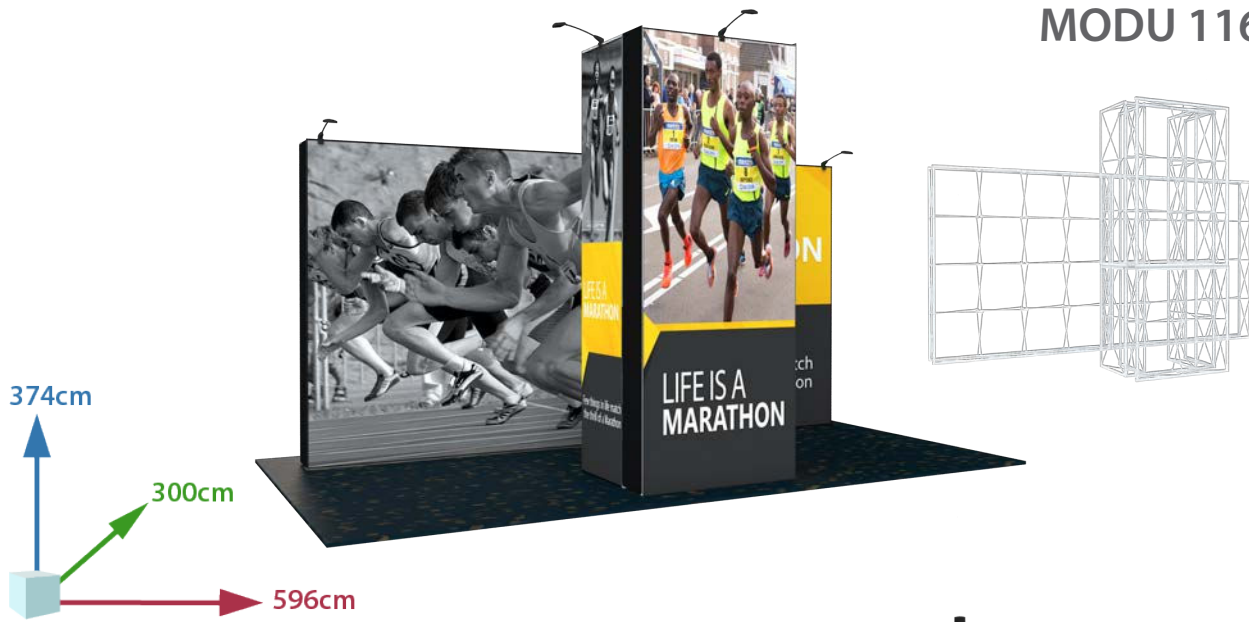

MODU 117

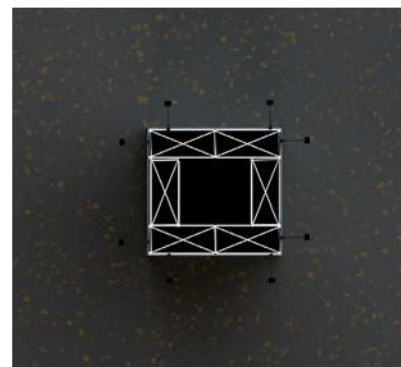

MODU 118



MODU 119



MODU 120

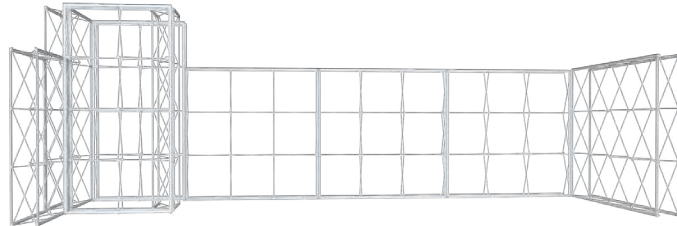
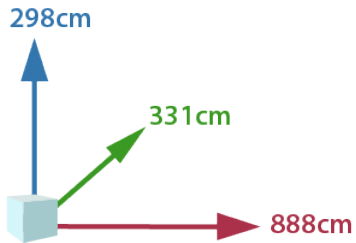

MODU 121

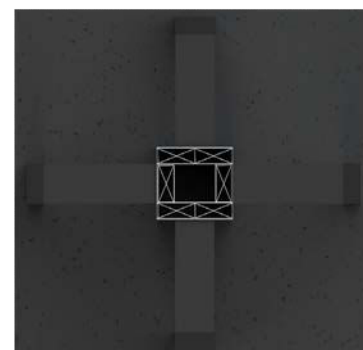
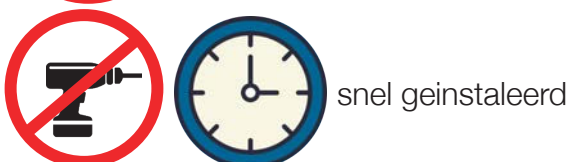
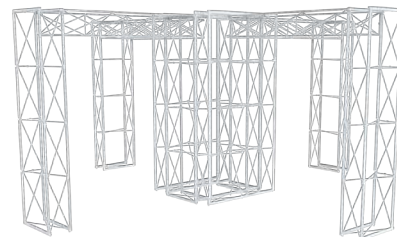
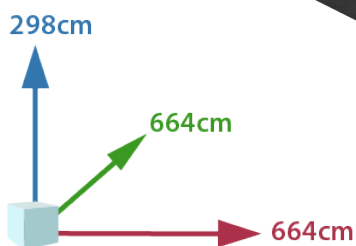

MODU 122

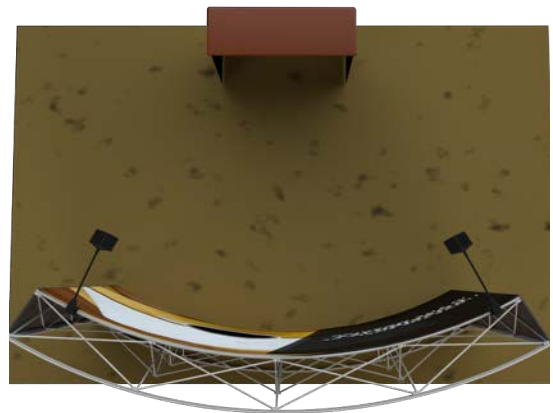
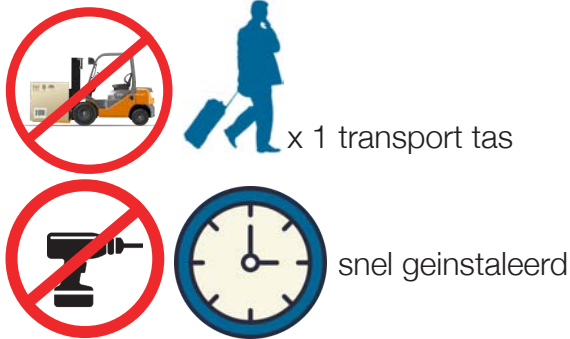

MODU 123

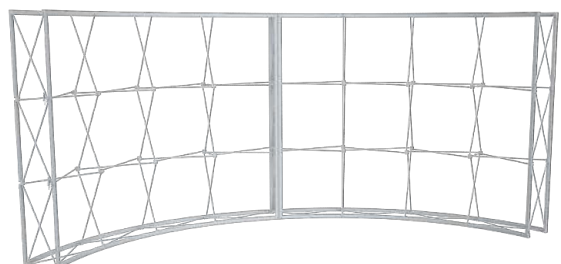
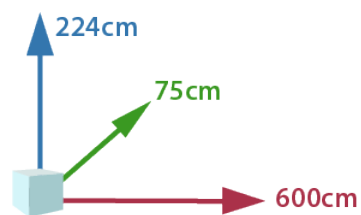

MODU 124

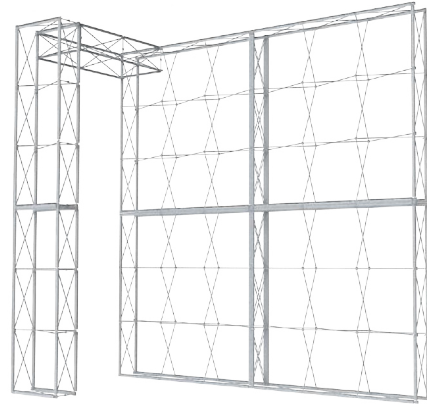
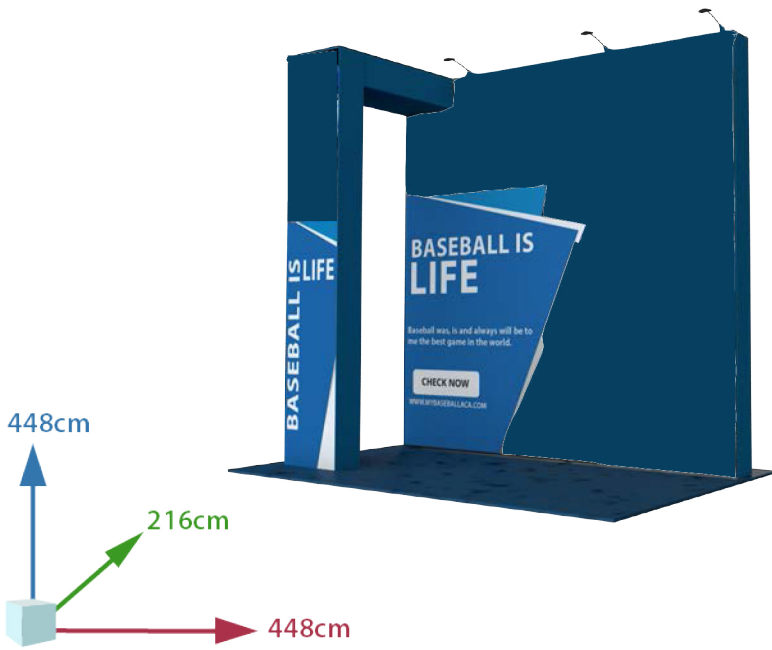

MODULAR LED COUNTER

MODULAR FABRIC COUNTER

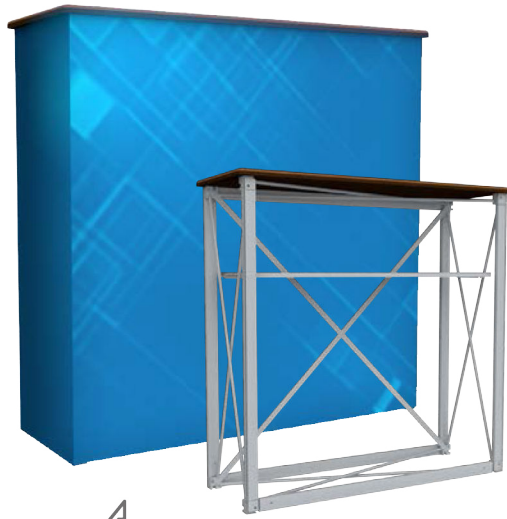
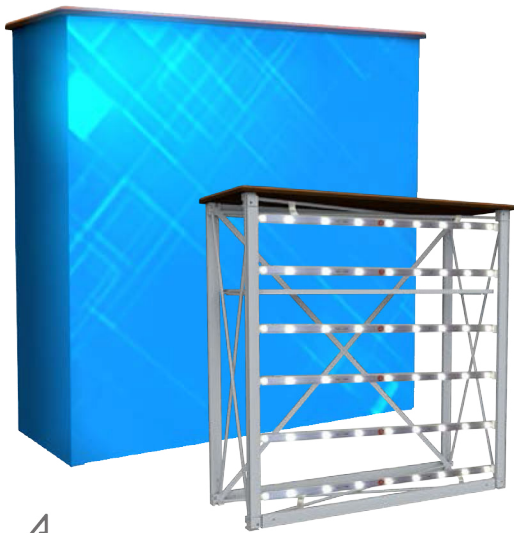

#2401: 100x100cm

#2402: 100x100cm



1 pc. per carton
1 Stk. im Karton
1 pc par carton
1st per doos



guaranteed quality
Qualitätsgarantie
qualité garantie
Kwaliteitsgarantie

MODULES STRAIGHT

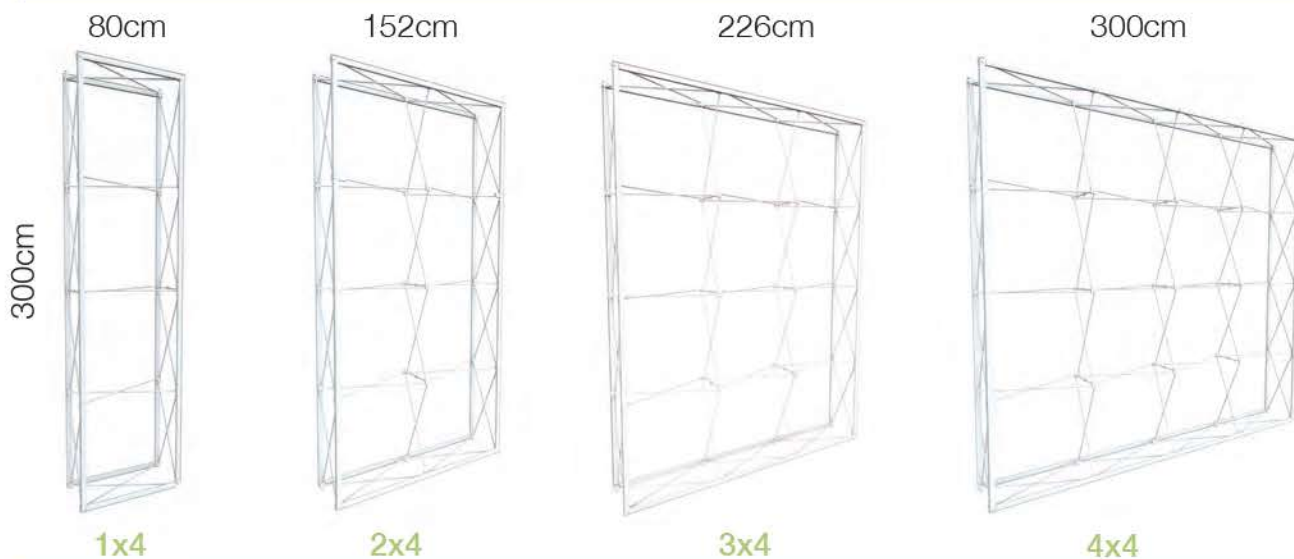
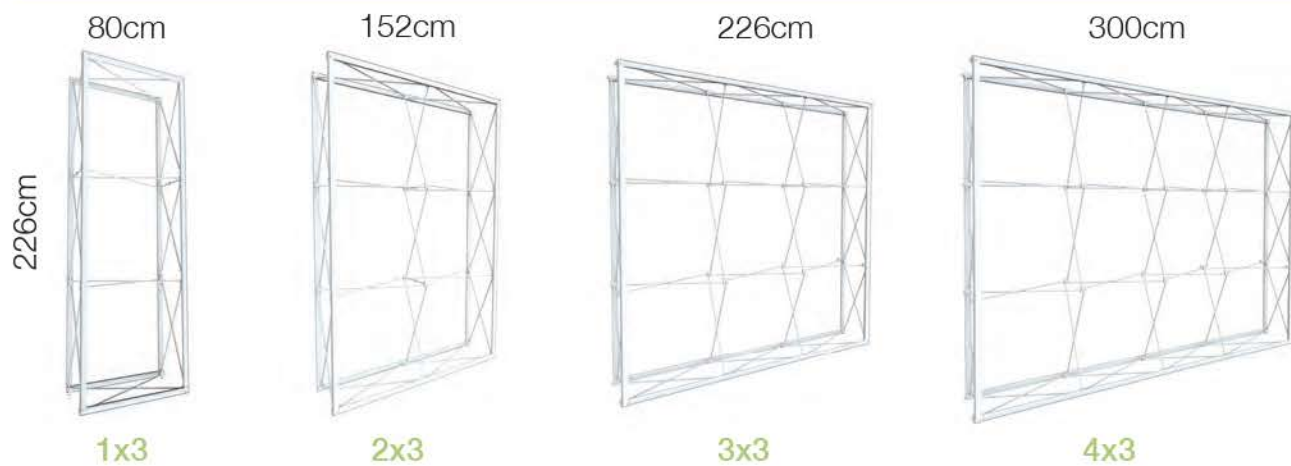
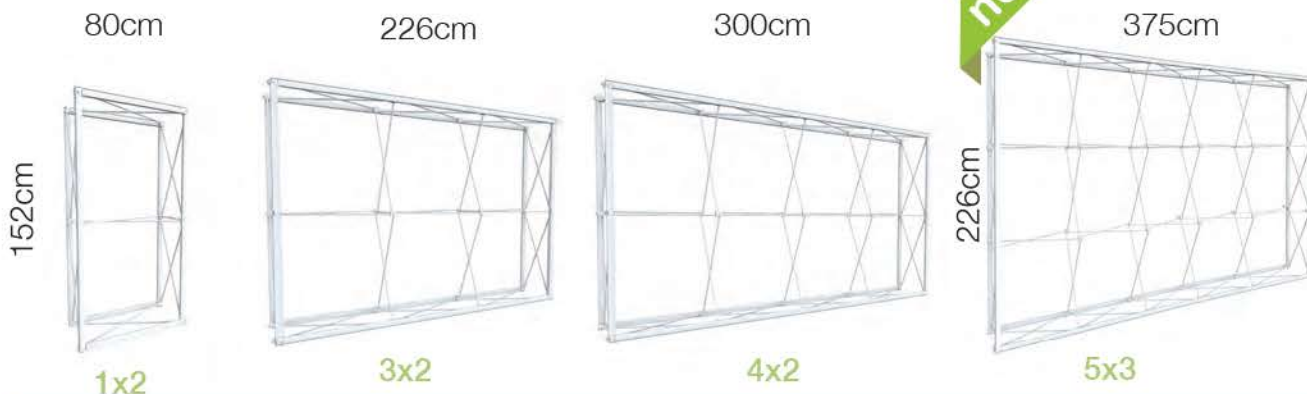

MODULES CURVED

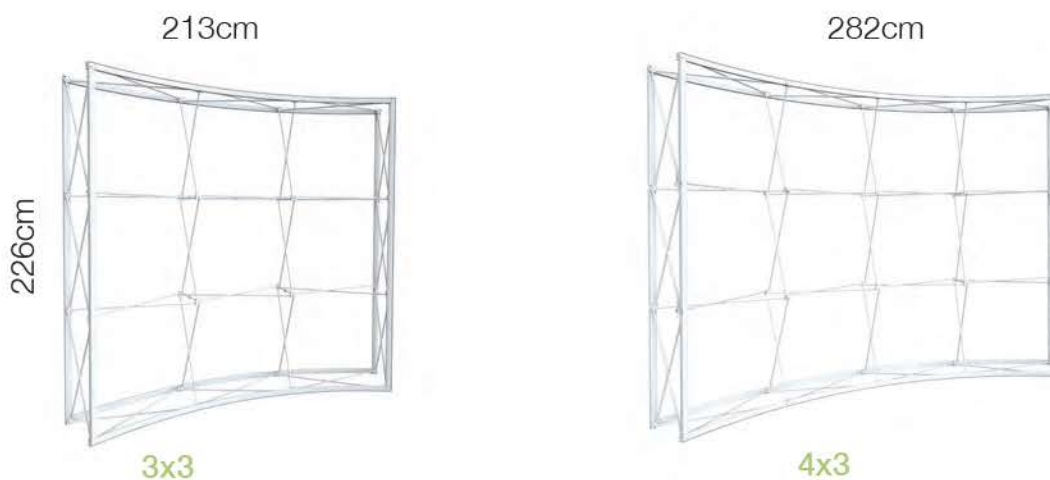

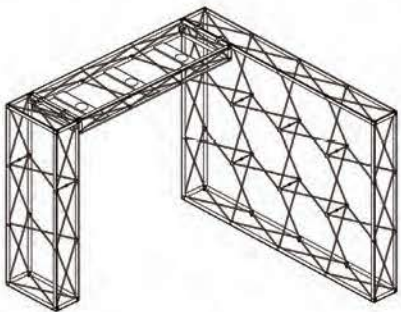

LED Kit for Bridge
9 Watt

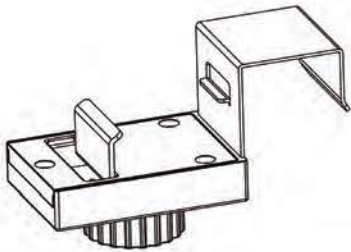
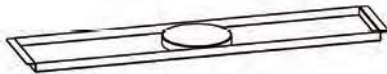

Bridge hook connector

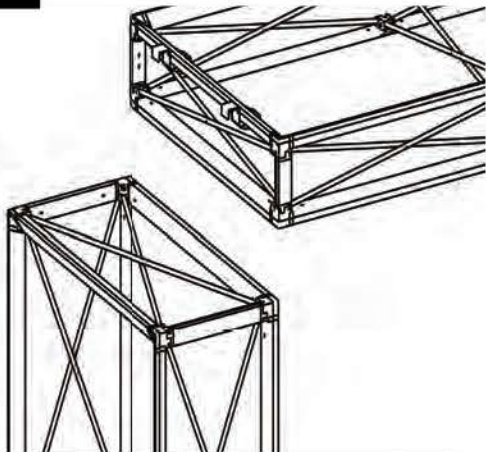

TV Bracket

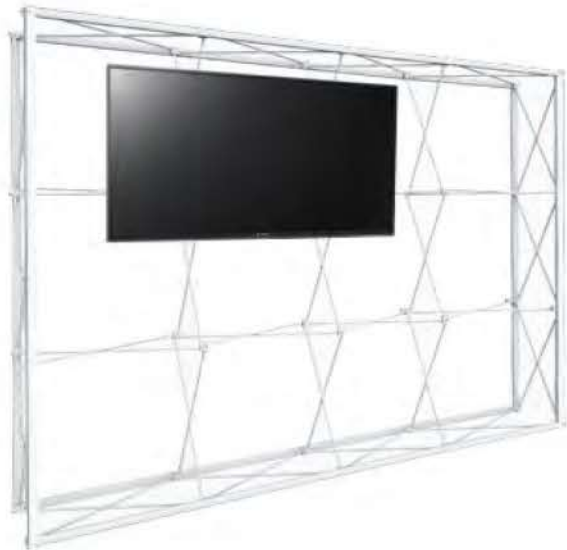

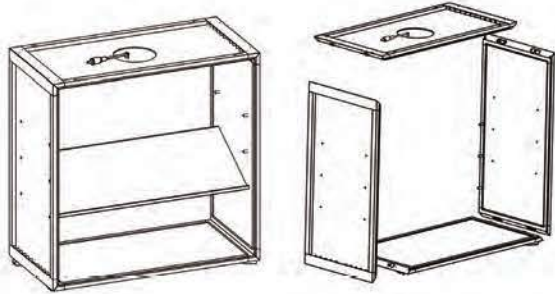

showcase

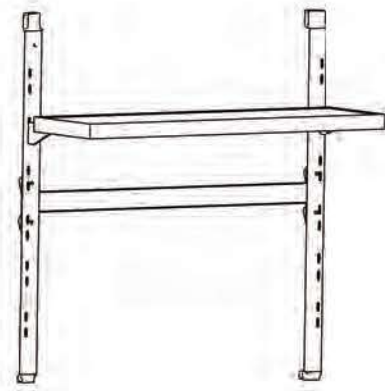

External shelf

