



ABC EXPO . BE

Portable & folding displays and stands
Layout, large format print, photography and lettering



DISPLAY 20 HANDBOOK 26



A creative solution for every need

Create greater brand awareness and stand out from the crowd

Our extensive portfolio of display products includes everything from portable A-sign boards, roller banners through to custom built exhibition stands, helping brands to creatively capture the attention of their target audience with a variety of display solutions and vibrant printed graphics.



Best seller



Made in Europe



1 Year hardware guarantee



Use with fabric graphic



3 Year hardware guarantee



Use with PVC graphic



5 Year hardware guarantee



Use with self-adhesive graphic



Comes with bag



Use with rigid panel graphic



Illuminated product



Direct printing onto hardware



Available for use outdoors



Made in UK



Custom sizes available

Contents

QuickLink	4
A solution for every requirement	6
Lightboxes	8
Illuminova™	10
Illumigo™	14
Display Stands	20
Modulate™	23
Vector	36
Fastframe™	57
Arena Structures	76
Hanging Structures	80
Display Backwalls	82
Pop-up Backwalls	84
Fabric Tube Walls	91
Display Banners	94
Roller Banners (economy)	97
Roller Banners (standard)	99
Roller Banners (premium)	101
Tension Banners	107
Tension Textile Systems	108
Display Signs	110
Free-Standing Signs	112
Wall Mounted and Suspended Signs	117
Display Boards	118
Digital Displays	124
Flags	130
Free-Standing Flags	132
Post / Wall Mounted Flags	136
Mobile Flags	137
Tents	138
Pop-up tents	140
Inflatable Tents / Parasol	143
Counters	144
Promotional counters	146
Illuminated Promotional Counters	150
Barriers	152
Pedestrian Control Barriers	154
Ancillaries	156
Literature Holders	158
Lighting	159
Lighting Ancillaries	161
Portable Transportation Cases	162
Index	166





A solution for every requirement

Our comprehensive range of Creative Display Solutions

Whether you are looking for a display stand to give your brand standout at an upcoming exhibition, or marketing collateral to support a pop-up store or event, our extensive product portfolio has you covered. Whatever your industry or application, we offer innovative creative display solution to give your messaging standout.

01 Lightboxes

Create outstanding visual impact with back lit or edge lit LED graphics, ideal for temporary, permanent and customised applications.



02 Display Stands

Complete exhibition stand solutions, incorporating hanging structures, modular stands, towers and customised stands



03 Display Backwalls

Large format graphic backdrops ideal for conferences, promotional activities and events



04 Display Banners

Portable display options, ideal for temporary deployment



05 Display Signs

Professional wall, floor and suspended signage solutions



06 Digital Displays

Captivate and connect with digital displays



07 Flags

Attract attention at a distance through movement with eye-catching flag solutions



08 Tents

Perfect temporary shelters, pop-up shops and market stalls for outdoor use



09 Counters

Adaptable and portable temporary counters for promotional, display and exhibition applications



10 Barriers

Easy and convenient barrier systems to manage queues, control crowds and create temporary areas



11 Ancillaries

Accessories designed to increase the functionality of a chosen product range



For outstanding visual impact in interior spaces, lightboxes are the perfect option.

Vibrant graphics, edge lit or back lit with energy saving LEDs, create focal points that add depth and drama to retail spaces, exhibition stands, commercial properties and beyond.

We offer two ranges of lightbox solutions. The Illuminova™ range combines vivid SEG fabric graphics with a sleek profile in a choice of standard or custom dimensions. For instant impact, our portable Illumigo™ range is available in a variety of standard sizes to bring your retail space to life.



illuminova™

The Illuminova™ range encompasses wall mounted, hanging and free-standing LED lightboxes in a choice of standard or custom sizes. Ideal for adding visual interest to feature walls and shop windows as well as transforming areas with low ambient lighting. Easily refreshed with updated graphics, Illuminova™ provides the perfect framework to display enhanced vibrant messaging.



iLLUMiGO™

The Illumigo™ LED lightbox range combines stunning graphic illumination with instant, tool-free assembly. For ease of transportation and storage, the aluminium LED frames are lightweight and come in a handy carry case. Simply update the graphics, for a fresh and sustainable way to transform spaces with light.

75mm Illuminova™ wall mounted



Create a striking focal point with the 75mm Illuminova™ LED edge lit wall mounted lightbox. Available in standard and custom sizes, the linkable LED lighting system delivers consistent lighting for a dramatic visual display.



Material	Aluminium
Profile width	75 mm
Profile Colour	Anodised Silver or custom White or Black
Assembly	Connectors assemble using Allen key
Mounting	Wall mounted
Graphic area	Single-sided
Graphic attachment	Silicone Edged Graphics (SEG)
LED System	Edge lit + Pre-installed LED lighting

illuminova™ 75mm wall mounted 1000x1000mm	iLLNO-75-10X10	⊙ 1000(w) x 1000(h) x 75(d) mm
illuminova™ 75mm wall mounted 1500x1500mm	iLLNO-75-15X15	⊙ 1500(w) x 1500(h) x 75(d) mm
illuminova™ 75mm wall mounted 2000x1000mm	ILLNO-75-20X10	⊙ 2000(w) x 1000(h) x 75(d) mm
illuminova™ 75mm wall mounted 2000x2000mm	ILLNO-75-20X20	⊙ 2000(w) x 2000(h) x 75(d) mm
illuminova™ 75mm wall mounted 3000x2000mm	ILLNO-75-30X20	⊙ 3000(w) x 2000(h) x 75(d) mm



Cable system



LED strip lighting



Numbered system for easy assembly



100mm Illuminova™ Free-standing



The double-sided 100mm Illuminova™ LED edge lit free-standing lightbox creates a dramatic visual statement for your interior displays. The linkable LED display system makes for a simple set up, whilst the SEG graphics can be easily replaced to support new messaging.

Material	Aluminium
Profile width	100 mm
Profile Colour	Anodised Silver
Assembly	Connectors assemble using Allen key
Graphic area	Double-sided
Mounting	Free-standing
Graphic attachment	Silicone Edged Graphics (SEG)
LED System	Edge lit + Pre-installed LED lighting

illuminova™ 100MM 3000X2000MM	ILLNO-100-30X20	3000(w) x 2007(h) x 550(d) mm
-------------------------------	-----------------	-------------------------------

Measurements include feet



Available in standard and custom sizes



Mitred sections assemble with Allen key connectors



Cable system



LED strip lighting

illumiNOVA® is a **breathtakingly vibrant** illuminated Display Solution.

125mm Illuminova™ Free-standing



For outstanding visual impact, the robust double-sided 125mm Illuminova™ LED edge lit free-standing lightbox is a must. Available in standard and custom sizes, the linkable LED display system ensures vibrant lighting across the SEG graphic.

Material	Aluminium
Profile width	125 mm
Profile Colour	Anodised Silver or custom white or black
Assembly	Connectors assemble using Allen key
Double-sided	Double-sided
Mounting	Free-standing
Graphic attachment	Silicone Edged Graphics (SEG)
LED System	Edge lit + Pre-installed LED lighting

Illuminova™ 125mm 3000x2000mm	ILLNO-125-30X20	⊖ 3000(w) x 2007(h) x 550(d) mm
Illuminova™ 125mm 3000x2500mm	ILLNO-125-30X25	⊖ 3000(w) x 2507(h) x 550(d) mm
Illuminova™ 125mm 4000x2000mm	ILLNO-125-40X20	⊖ 4000(w) x 2007(h) x 550(d) mm

Measurements include feet

Available in standard and custom sizes



Cable system



LED strip lighting



Mitred sections assemble with Allen key connectors

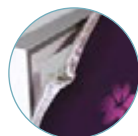

Silicone Edged Graphics (SEG)

125mm Illuminova™ Hanging Structure



Ideal for exhibitions and retail venues, the 125mm Illuminova™ hanging LED structure is the perfect medium for brand messaging and wayfinding. Sleek, yet lightweight and robust, the double-sided aluminium frame is edge lit with energy efficient LEDs for an eye-catching suspended display. Available in standard and custom sizes, this vibrant lightbox creates the perfect backdrop for dynamic SEG graphics.

Material	Aluminium
Profile width	125 mm
Profile Colour	Anodised Silver. White and black are available as custom
Assembly	Sling (cables not included). Connectors assemble using Allen key
Double-sided	Double-sided
Mounting	Hanging
Graphic attachment	Silicone Edged Graphics (SEG)
LED System	Edge lit + Pre-installed LED lighting

illuminova™ 125mm hanging 2500x1000mm	ILLNOH-125-25X10	⊗ 2500(w) x 1000(h) x 125(d) mm
illuminova™ 125mm hanging 3500x1000mm	ILLNOH-125-35X10	⊗ 3500(w) x 1000(h) x 125(d) mm
illuminova™ 125mm hanging 5000x1250mm	ILLNOH-125-50X12	⊗ 5000(w) x 1250(h) x 125(d) mm



Cable system



LED strip lighting

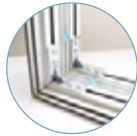

Mitred sections assemble with Allen key connectors

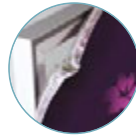

Silicone Edged Graphics (SEG)



Introducing The Illumigo™ Modular Lightbox System Designed for Wide-Format Visual Standout



ILLGO-MOD-1824
1850mm(w)



ILLGO-MOD-2824
2850mm(w)



ILLGO-MOD-3824
3850mm(w)



ILLGO-MOD-4824
4850mm(w)



ILLGO-MOD-5824
5850mm(w)

Illumigo™ Modular



Illumigo™ Modular is a striking large-format illuminated display system, standing at 2380 mm high and engineered for exceptional visual impact. Designed with flexibility in mind, it delivers seamless edge-lit SEG graphics across widths up to 7.85 metres, making it a standout choice for retail spaces, exhibitions and promotional environments, all without the premium price tag.

Whether you are creating a wide backwall or an immersive multi-sided layout, the system supports large-scale continuous displays and dynamic configurations. Five frame widths are available: 1850 mm, 2850 mm, 3850 mm, 4850 mm and 5850 mm, alongside two extension panels (850 mm and 1000 mm), which accommodate seamless graphics across multiple sections. The sleek, 120 mm deep aluminium profile is powder coated in white for a clean, professional finish.

Make a bold visual statement with L, T and U-shaped structures that showcase illuminated graphics from multiple angles. With three connector types (sold separately), it is easy to build creative shaped configurations that turn heads. Two optional foot styles provide added stability and aesthetic flexibility, and an A4 literature holder (sold separately) is available to complete your setup.

Material	Aluminium
Profile width	120mm
Profile Colour	White
Assembly	Tool-free
Graphic area	Double-sided
Graphic attachment	Silicone Edged Graphics (SEG)
Application	Self-supporting
Transport	Wheeled carry bag

Illumigo™ Modular	ILLGO-MOD-1824	⊙ 1850(w) x 2380(h) x 590(d) mm
Illumigo™ Modular	ILLGO-MOD-2824	⊙ 2850(w) x 2380(h) x 590(d) mm
Illumigo™ Modular	ILLGO-MOD-3824	⊙ 3850(w) x 2380(h) x 590(d) mm
Illumigo™ Modular	ILLGO-MOD-4824	⊙ 4850(w) x 2380(h) x 590(d) mm
Illumigo™ Modular	ILLGO-MOD-5824	⊙ 5850(w) x 2380(h) x 590(d) mm



Pre-installed LEDs



Push fit



Branded Carry Back with wheels



Optional A4 literature stand ILLGO-LH-A4

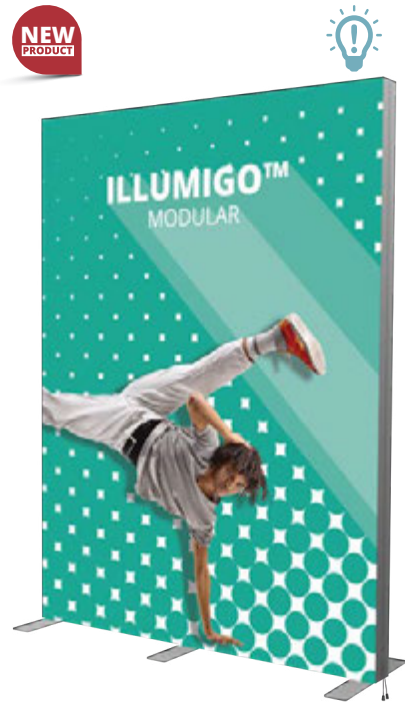

← Expand to 7.85 metres →

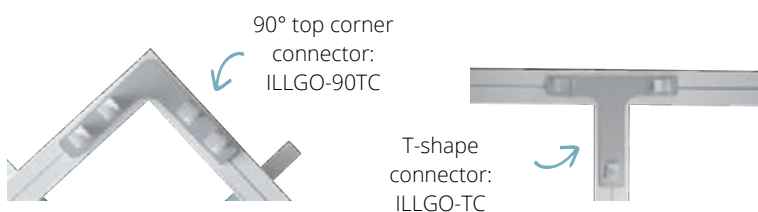
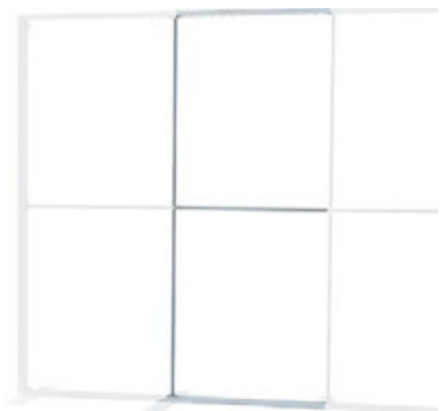

Illuminated lightbox that sits within your shell scheme walls, fast and flexible
Simple, illuminated solution: Illumigo™ Modular is a backlit lightbox system designed to install inside the walls of an existing shell scheme



3x5 shell scheme



Illumigo™ Lite Mag



Illumigo™ Lite Mag is a high-impact illuminated display designed to deliver style, versatility, and affordability in one sleek solution. Featuring an elegant 80mm white aluminium profile and double-sided illumination, it offers exceptional brightness and presence in any setting - from exhibitions and retail spaces to corporate environments.

Its innovative design includes a unique perimeter channel that allows multiple frames to be effortlessly linked together in L-shapes, T-shapes, or straight-line configurations, providing endless creative possibilities for modular display layouts.

Built-in magnetic connections make assembly and reconfiguration fast and tool-free, ensuring precise alignment and effortless setup every time. The system can also be enhanced with optional accessories such as A4 literature holders, adding functionality to its clean, contemporary design.

Material	Aluminium
Profile width	80mm
Profile Colour	White
Assembly	Tool-free
Graphic area	Single-sided
Graphic attachment	Silicone Edged Graphics (SEG)
Application	Self-supporting with pivoting feet fixed to the structure
Transport	Branded bag with carry handle and wheels

Illumigo™ Lite Mag	ILLGO-LITE-MAG	Ⓞ 1000(w) x 2020(h) x 400(d) mm
--------------------	----------------	---------------------------------

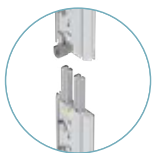

Tool-free Assembly



Twist out feet



Built in Magnets

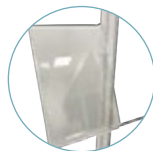

Optional A4 literature stand ILLGO-LH-A4

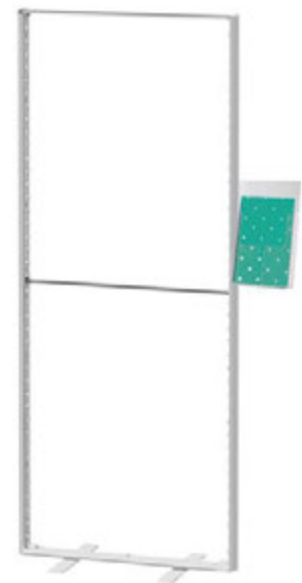
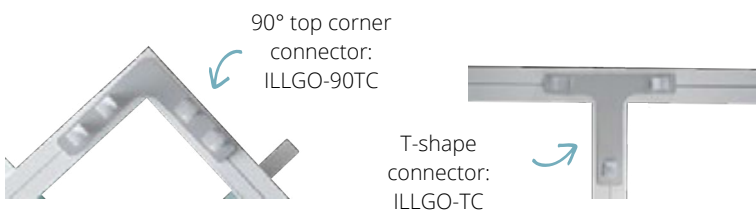

Illumigo™ One



Illumigo™ One is a vibrant portable single-sided lightbox with the option to have a rear-facing textile graphic unit. Standing 2000mm high and 850mm wide, the slim 60mm profile has a white powder coated finish and benefits from tool-free plug and play assembly due to an easy to follow numeric system, rollable LED panel and pre-assembled twist-out feet.



Material	Aluminium
Profile width	60 mm
Profile Colour	White
Assembly	Tool-free
Graphic area	Single-sided
Graphic attachment	Silicone Edged Graphics (SEG)
Application	Self-supporting with pivoting feet fixed to the structure
Transport	Protective box with carry handle

Illumigo™ One	ILLGO-ONE	Ⓞ 850(w) x 2010(h) x 390(d) mm
---------------	-----------	--------------------------------

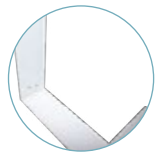

Tool-free assembly

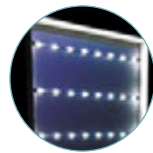

Rollable LED panel



Single-sided frame



Optional Illumigo™ bag



850 mm

Illumigo™ Retail



Illumigo™ Retail is an innovative portable LED lightbox that is specifically designed for retail environments because of its size and stability. The 1600 x 600mm double-sided illuminated display comes in a protective compartmented box with handle for ease of transportation. Deploys tool-free in minutes thanks to pre-assembled LED lighting and SEG optional dye-sublimated graphics.



Material	Aluminium
Profile width	100 mm
Profile Colour	White
Assembly	Tool-free
Graphic area	Double-sided
Graphic attachment	Silicone Edged Graphics (SEG)
Application	Self-supporting with flat base fixed to the structure
Transport	Protective box with carry handle

Illumigo™ Retail	ILLGO-RETAIL	Ⓞ 600(w) x 1600(h) x 285(d) mm
------------------	--------------	--------------------------------



Pre-installed LED lights



Connector



Branded protective compartmented box



Optional Illumigo™ bag



600 x 1600 mm

Illumigo™ 2x2



Illumigo™ is a complete portable 2x2m double-sided aluminium lightbox display system. Simple to deploy with tool-free assembly. Just remove from the box, twist out the feet from the base panel and use the matching numerical system to connect the remaining extrusions remembering to insert the horizontal bar. SEG graphics fit into the frame channel and the power cable inserts under the base panel. Ready to go in less than 10 minutes!



Material	Aluminium
Profile width	100 mm
Profile Colour	White
Assembly	Tool-free
Graphic area	Double-sided
Graphic attachment	Silicone Edged Graphics (SEG)
Application	Self-supporting with pivoting feet fixed to the structure
Transport	Protective box with carry handle



Illumigo™ 2x2	ILLGO-2X2	Ⓞ 2000(w) x 2010(h) x 400(d) mm
---------------	-----------	---------------------------------



Metal straight connector



Numbered system for easy assembly



Illumigo™ Counter



This versatile and quick to set-up double-sided counter lightbox is a great all-rounder not only at events but in retail environments from shopping centres to pop-up shops. Part of the Illumigo™ range, the Illumigo™ Counter is easy to assemble with a two-part counter-top that secures using a pair of twist out top locators and locking screws. Building the unit is intuitive and tool-free as all the parts are numbered and simply slot together. Two optional graphics complete the look to create an impactful counter ideal for attracting attention in retail, event or exhibition environments.

Material	Aluminium 100 mm, MDF table top
Assembly	Tool-free
Collapsible	Yes
Counter top	White
Graphic attachment	Silicone Edged Graphics (SEG)
Transport	Protective box with carry handle
LED System	Led strips included

Illumigo™	ILLGO-COUNTER	Ⓞ 1040(w) x 1045(h) x 420(d) mm
Illumigo™ Bag	ILLGO-BAG	Ⓞ 460(w) x 1160(h) x 190(d) mm



Optional Illumigo™ bag



Protective compartmented box

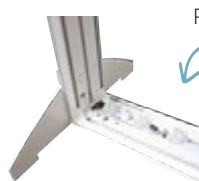

Pre-assembled LEDs in the frame



Steel side feet for stability



Display Stands are the perfect solution for an array of different applications.

From exhibitions, conferences, events, retail event zones to window displays and product showrooms; their uses are unlimited. The perfect stand will showcase and increase the opportunity to interact with existing and potential customers by creating engaging, and innovative brand promotion and messaging.



Modulate™



Fastframe™

Vector

Stand component systems

Modulate™

Modulate™ is the fusion between two of our original concepts: Formulate and Vector. The range is composed of various frames made of aluminium tubes, equipped with the patented magnet system: MagLink.

Modulate™ provides a custom build solution through its hundreds of possible configurations using the various modules.

Vector

One of the simplest and most versatile communication solutions on the market, Vector is an aluminium frame system with a stretched fabric graphic that adapts to any environment. With a variety of different profiles, all applications are possible: suspended, wall-mounted, self-supporting, double-sided or illuminated utilising Illuminova™.

Fastframe™

A unique pre-assembled foldable framework for fast construction and endless Creative Display Solutions - the perfect seamless backdrop for visually striking SEG graphics.

Arena

Arena is a tubular aluminium gantry structure that is both extremely strong and light. The different sections can be assembled according to the space and can be covered with fabric or vinyl graphics.

Hanging Structures

Select one of our lightweight Formulate hanging structures to complement your stand design, which uses a lightweight 30mm tubular system that can be neatly wrapped in a fabric printed graphic.

MODULATE™

VECTOR

FASTFRAME™
TRANSFORM SPACES IN SECONDS

Considerations for exhibitions

Why exhibit at a trade show?

Trade shows remain the preferred communication channel for companies seeking to increase their reputation and promote their image.

The benefits of a trade show are vast and very attractive. They enable several actions to be carried out in a relatively short period of time:

- Brand positioning
- Prospecting
- Market research
- Product launches
- Building customer loyalty
- Business networking

The centrepiece: your stand

The success of any trade show depends on its cost vs quality and ROI for generating leads and meeting other sales / marketing objectives.

1. Location:

How much space? How many open sides?

2. The design:

Which media: textile, rigid, flexible panels?

Need to communicate in height: sign,

extension or extension of storage room?

Do you need a storeroom to store equipment?

What kind of lighting?

3. Use:

How often?

Will it need to be scalable in shape and size?

What means of transport do you have?

Will the stand be reused in another environment

i.e. customer showroom, inhouse events etc.?

4. The budget :

What is the budget for the stand?

Over how many shows will it pay for itself?

The keys to success

To have a successful trade show, it is essential to:

- Set 3 to 5 objectives that will guide the marketing strategy of the event
- Ensure maximum visual impact with a quality stand that will enhance the company's image (openings, suspended communication, graphics, materials, etc.)
- Implement effective communication and promotion: before, during and after the event (emailing, invitation, social networks, stand promotion, etc.)

Why choose a modular stand?

- Lightweight and compact
- Reconfigurable
- Quick payback
- Durable
- Easy to assemble
- Standard or custom made
- Unlimited message renewal
- Ergonomically friendly



MODULATE™



Modulate™

The best way to attract attention

Modulate™ is the fusion of two original concepts that have proven successful in the exhibition and retail worlds; Formulate and Vector.

Modulate™ is a collection of various frames made from aluminum tubes and covered with a printed textile cover. These frames can be easily connected to each other by means of powerful magnets placed inside each structure.

Based on this simple magnetic principle, it is possible to combine the different Modulate™ frames to create configurations for all communication areas: at the point of sale, at trade shows, in exhibition areas, in shopping centres or simply within companies themselves.

MagLink connector, simple, fast and reconfigurable



Thanks to the exclusive MagLink magnetic system integrated into the structure, you can connect the frames to each other simply by bringing them together.

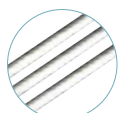
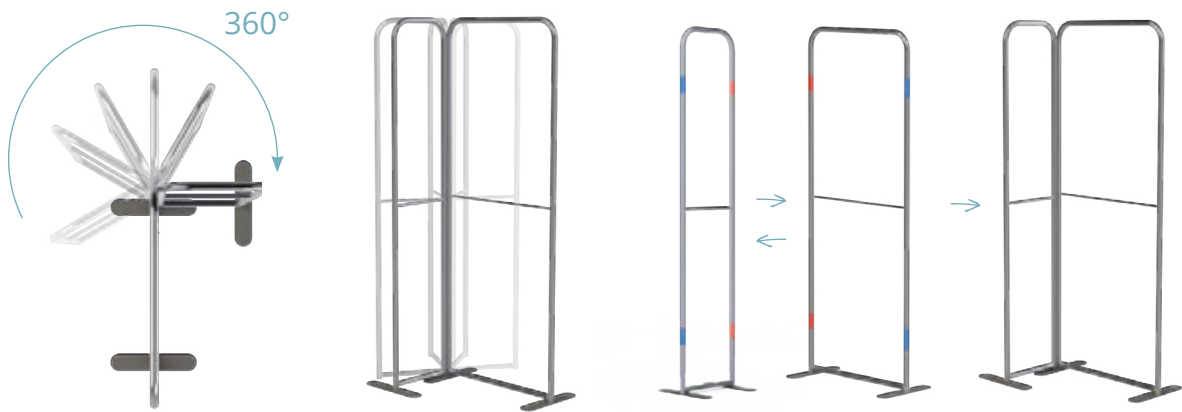

Optional 400 mm extension to change the height of the structures



MagLink connectors 360° in each post



Modulate™ carry bag with dedicated slots for feet and graphics



Intuitive marking on each section for easy assembly

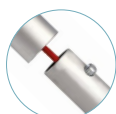

Self-locking system with a push-fit button



Rounded or straight corners with the reference MOD-SQ-ANGLE



2 stabilising feet with Twist & Lock system, supplied with each frame



Central reinforcement bar (18 mm diameter)



Double-sided custom printed fabric graphic that zips closed

Tool-less assembly

Modulate™ structures are easy to assemble without tools. Each section is marked with numbers and colours and connected with push buttons. Once the structure is assembled, the Twist & Lock feet will rotate a quarter of a turn until they lock into a perfectly stable self-supporting frame. Finally pull-on the printed fabric graphic which perfectly fits to the contour of the frame.

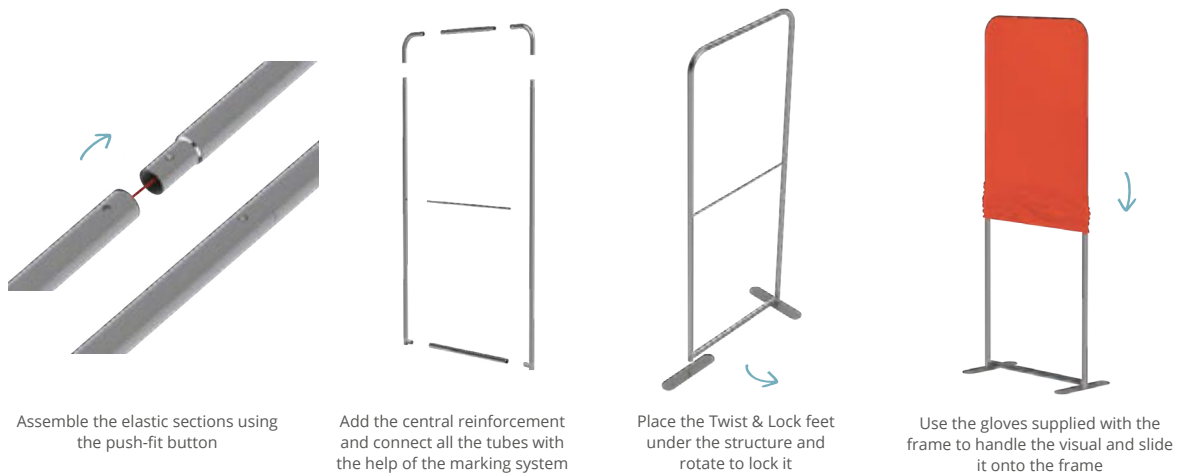

Twist & Lock Foot installation

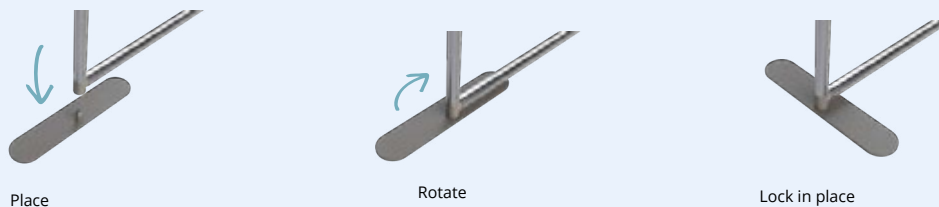

Structures with unique technological innovations

To add versatility to Modulate™ structures, a 400 mm tubular extension can be added. With this extension, which is easily placed between two sections, you can use the same frame with two different heights.

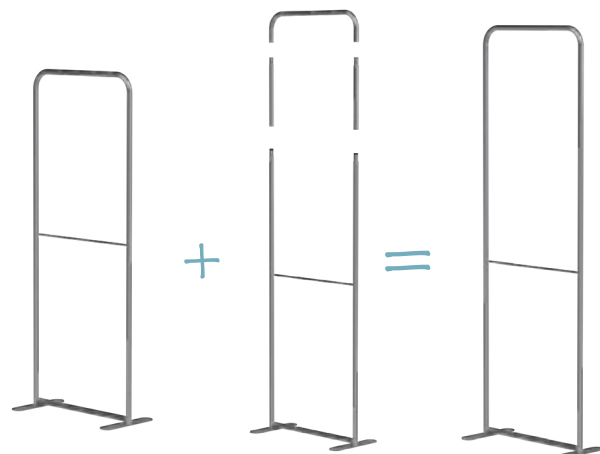

Standard Modulate™ Frames

Modulate™ is an innovative double-sided display system that consists of a set of lightweight aluminium frames covered with a custom printed tension fabric graphic. Frames connect together using powerful magnets encased inside each element and can be joined at any angle to create shaped displays or backwalls. Frames are completed by pulling a tension-fit fabric graphic over the frame and zipping at the base. Frames are available in various widths and two height options. Each frame is supplied with two stabilising feet which can be used if required for extra stability. The Modulate™ Straight frames can be used on their own or combined with other frames to create hundreds of configurations.

Material	Aluminium
Tube	30mm Ø
Assembly	Tool-free push-button connectors
Shape	Straight
Graphic area	Double-sided
Graphic attachment	Zipped tension-fit graphic
Application	Free-standing with feet (included)
Transport	Modulate™ carry bag with dedicated pockets for the feet and graphics

Modulate™ Straight

Modulate™ Straight 420, 424



Straight 420 rounded corners	MOD-S-420	Ⓞ 418(w) x 2000(h) x 400(d) mm
Straight 424 rounded corners	MOD-S-424	Ⓞ 418(w) x 2400(h) x 400(d) mm
Straight 420 square corners	MOD-S-420-SQ	Ⓞ 418(w) x 2000(h) x 400(d) mm
Straight 424 square corners	MOD-S-424-SQ	Ⓞ 418(w) x 2400(h) x 400(d) mm



Modulate™ Straight 820, 824



Straight 820 rounded corners	MOD-S-820	Ⓞ 818(w) x 2000(h) x 400(d) mm
Straight 824 rounded corners	MOD-S-824	Ⓞ 818(w) x 2400(h) x 400(d) mm
Straight 820 square corners	MOD-S-820-SQ	Ⓞ 818(w) x 2000(h) x 400(d) mm
Straight 824 square corners	MOD-S-824-SQ	Ⓞ 818(w) x 2400(h) x 400(d) mm



Modulate™ Straight 1020, 1024



Straight 1020 rounded corners	MOD-S-1020	Ⓞ 1018(w) x 2000(h) x 400(d) mm
Straight 1024 rounded corners	MOD-S-1024	Ⓞ 1018(w) x 2400(h) x 400(d) mm
Straight 1020 square corners	MOD-S-1020-SQ	Ⓞ 1018(w) x 2000(h) x 400(d) mm
Straight 1024 square corners	MOD-S-1024-SQ	Ⓞ 1018(w) x 2400(h) x 400(d) mm



Key

420, 424		2020, 2024	
820, 824		3020, 3024	
1020, 1024		Slope	
1820, 1824		Door	

Modulate™ Straight 1820, 1824



Straight 1820 rounded corners	MOD-S-1820	☉ 1818(w) x 2000(h) x 400(d) mm
Straight 1824 rounded corners	MOD-S-1824	☉ 1818(w) x 2400(h) x 400(d) mm
Straight 1820 square corners	MOD-S-1820-SQ	☉ 1818(w) x 2000(h) x 400(d) mm
Straight 1824 square corners	MOD-S-1824-SQ	☉ 1818(w) x 2400(h) x 400(d) mm



Modulate™ Straight 2020, 2024



Straight 2020 rounded corners	MOD-S-2020	☉ 2018(w) x 2000(h) x 400(d) mm
Straight 2024 rounded corners	MOD-S-2024	☉ 2018(w) x 2400(h) x 400(d) mm
Straight 2020 square corners	MOD-S-2020-SQ	☉ 2018(w) x 2000(h) x 400(d) mm
Straight 2024 square corners	MOD-S-2024-SQ	☉ 2018(w) x 2400(h) x 400(d) mm



Modulate™ Straight 3020, 3024



Straight 3020 rounded corners	MOD-S-3020	☉ 3018(w) x 2000(h) x 400(d) mm
Straight 3024 rounded corners	MOD-S-3024	☉ 3018(w) x 2400(h) x 400(d) mm
Straight 3020 square corners	MOD-S-3020-SQ	☉ 3018(w) x 2000(h) x 400(d) mm
Straight 3024 square corners	MOD-S-3024-SQ	☉ 3018(w) x 2400(h) x 400(d) mm



Modulate™ Slope

Modulate™ Slope



Material	Aluminium
Tube	30mm Ø
Assembly	Tool-free push-button connectors
Shape	Straight
Graphic area	Double-sided
Graphic attachment	Zipped tension-fit graphic
Application	Free-standing with feet (included)
Transport	Modulate™ carry bag with dedicated pockets for the feet and graphics

Slope 1	MOD-SS-824-01	⊗ 818(w) x 2300(h) x 400(d) mm
Slope 2	MOD-SS-824-02	⊗ 818(w) x 2400(h) x 400(d) mm



Slope 1

Slope 2



Modulate™ Door



The Modulate™ Door frame joins magnetically to other frames in the Modulate™ range and is tool-free in its design. Constructed from lightweight aluminium tubing with magnets held in the frames to join backwalls together. Complete with optional tension-fit fabric graphic, the door is ideal for store room areas or meeting rooms.

Material	Aluminium
Tube	30mm Ø
Assembly	Tool-free push-button connectors
Shape	Straight
Graphic area	Double-sided
Graphic attachment	Zipped tension-fit graphic
Application	Free-standing with feet (included)
Transport	Modulate™ carry bag with dedicated pockets for the feet and graphics

Modulate™ door rounded corners	MOD-S-DOOR-820	⊗ 800(w) x 2000(h) x 120(d) mm
	MOD-S-DOOR-824	⊗ 800(w) x 2400(h) x 120(d) mm
Modulate™ door square corners	MOD-S-DOOR-820-SQ	⊗ 800(w) x 2000(h) x 120(d) mm
	MOD-S-DOOR-824-SQ	⊗ 800(w) x 2400(h) x 120(d) mm



2 handles and 1 stop for Modulate™ door included



An adjustable foot included



2 Twist & Lock square feet



The Modulate™ Door can be used with either a left or right-hand handle

Modulate™ ancillaries

Modulate™ Half Feet (pair)

MOD-HALF-FOOT-P	⊗ 80(w) x 6(h) x 215(d) mm
-----------------	----------------------------



Modulate™ Feet (pair)

MOD-FOOT-P	⊗ 80(w) x 6(h) x 400(d) mm
------------	----------------------------



Modulate™ 400mm Extension Kit

MOD-EXT400MM	⊗ 3 tubes 400(h) x 30 (Ø) mm
--------------	------------------------------



Modulate™ Square Corner

MOD-SQ-ANGLE	
--------------	--



Spotlight Clamp for Formulate / Modulate™ Tube

US903	⊗ 48(w) x 32(h) x 50(d) mm
-------	----------------------------



Modulate™ Counter



Modulate™ Counter consists of an innovative aluminium tubular frame, counter-top, and printed tension fabric graphic. Powerful magnets encased inside the frame enables two or more counters to connect using simple magnetic principles. The counter can be used on its own or combined to make a long reception or bar area. Modulate™ Counter can be deployed in minutes, thanks to the tool-less construction. The printed tension fabric graphic will either sit on or under the counter-top to suit the application.

Material	Ø 30mm Aluminium tubes, MDF tabletop/shelf
Assembly	Push-fit button
Collapsible	Yes
Counter top	Black
Shelves	1 (Optional)
Graphic attachment	Zip system
Transport	One padded carry bag, internal flap

Modulate™ Counter	FORM-MOD-CNTR	⊗ 1015(h) x 800(w) x 600(d) mm
Internal shelf	FORM-MOD-CNTR-02	⊗ 9(h) x 770(w) x 571(d) mm

PATENT PENDING

Use it on its own or combined, simply by using the integrated magnets!

Pre-configured Modulate™ stand examples

This section showcases examples of various pre-configured Modulate™ Stands that can be achieved using the various Modulate™ hardware and ancillaries.

Modulate™ Stand 6m²



Material	Aluminium	
Tube	30mm Ø	
Assembly	Tool-free push-button connectors	
Graphic area	Double-sided	
Graphic attachment	Zipped tension-fit graphic	

Modulate 800w x 2400h squared corners	1	MOD-S-824-SQ
Modulate 1800w x 2400h squared corners	2	MOD-S-1824-SQ
Modulate 2000w x 2400h squared corners	1	MOD-S-2024-SQ
Half foot (pair)	3	MOD-HALF-FOOT-P
Formulate oval counter	1	FORM-OVAL-CNTR
LED floodlight (x2 + 1 driver)	2	LED-FLOOD-ARM-BDLK
Spot light clamp for modulate	4	US903



Optional Spot
LED-FLOOD-ARM-BDLK



Clamp US903



Supplied with product bags

Modulate™ Stand 9m²



Material	Aluminium
Tube	30mm Ø
Assembly	Tool-free push-button connectors
Graphic area	Double-sided
Graphic attachment	Zipped tension-fit graphic

Modulate 800w x 2400h squared corners	3	MOD-S-824-SQ
Modulate 2000w x 2400h squared corners	2	MOD-S-2024-SQ
Modulate door 800w x 2400h squared corners	1	MOD-S-DOOR-824-SQ
Half foot (pair)	4	MOD-HALF-FOOT-P
Modulate magnetic counter	1	FORM-MOD-CNTR
Modulate counter shelf	1	FORM-MOD-CNTR-02
LED floodlight (x2 + 1 driver)	2	LED-FLOOD-ARM-BDLK
Spot light clamp for modulate	4	US903



Modulate™ cupboard
perfect for storage



Scalable stands go from
9m² to 15m²



Optional Spot
LED-FLOOD-ARM-BDLK



Clamp US903



Supplied with product bags

Modulate™ Stand 12m²



Material	Aluminium
Tube	30mm Ø
Assembly	Tool-free push-button connectors
Graphic area	Double-sided
Graphic attachment	Zippered tension-fit graphic

Modulate 800w x 2400h squared corners	3	MOD-S-824-SQ
Modulate 1000w x 2400h squared corners	1	MOD-S-1024-SQ
Modulate 2000w x 2400h squared corners	2	MOD-S-2024-SQ
Modulate door 800w x 2400h squared corners	1	MOD-S-DOOR-824-SQ
Half foot (pair)	3	MOD-HALF-FOOT-P
Insta LED counter	1	INSTA-CNTR-BLK
Formulate accent 15	1	FMLT-WL15
LED floodlight (x2 + 1 driver)	2	LED-FLOOD-ARM-BDLK
Spot light clamp for modulate	4	US903



Optional Spot
LED-FLOOD-ARM-BDLK

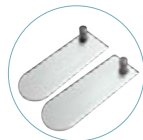

Half feet
Twist & Lock
MOD-HALF-FOOT-P
grey



2 handles and 1 stop
for Modulate™ Door
MOD-S-DOOR-SP-01
included

Modulate™ Stand 15m²



Material	Aluminium
Tube	30mm Ø
Assembly	Tool-free push-button connectors
Graphic area	Double-sided
Graphic attachment	Zippered tension-fit graphic

Modulate 800w x 2400h squared corners	1	MOD-S-824-SQ
Modulate 1000w x 2400h squared corners	2	MOD-S-1024-SQ
Modulate 1800w x 2400h squared corners	2	MOD-S-1824-SQ
Modulate 3000w x 2400h squared corners	1	MOD-S-3024-SQ
Modulate door 800w x 2400h squared corners	1	MOD-S-DOOR-824-SQ
Half foot (pair)	3	MOD-HALF-FOOT-P
Accent 05 - with TV bracket	1	FMLT-WBWA-05-TVH
Insta LED counter	1	INSTA-CNTR-BLK
Illuminova 125mm hanging 2500x1000	1	ILLNOH-125-25x10
LED floodlight (x2 + 1 driver)	3	LED-FLOOD-ARM-BDLK
Spot light clamp for modulate	6	US903



Optional Spot
LED-FLOOD-ARM-BDLK



Half feet
Twist & Lock
MOD-HALF-FOOT-P



Accessorise with a
Modulate™ counter

Modulate™ Stand 18m²



Material	Aluminium
Tube	30mm Ø
Assembly	Tool-free push-button connectors
Graphic area	Double-sided
Graphic attachment	Zippered tension-fit graphic

Modulate 800w x 2400h Squared Corners	1	MOD-S-824-SQ
Modulate 1000w x 2400h Squared Corners	2	MOD-S-1024-SQ
Modulate 1800w x 2400h Squared Corners	2	MOD-S-1824-SQ
Modulate 3000w x 2400h Squared Corners	1	MOD-S-3024-SQ
Modulate Door 800w x 2400h Squared Corners	1	MOD-S-DOOR-824-SQ
Half Foot (Pair)	3	MOD-HALF-FOOT-P
Insta LED Counter	1	INSTA-CNTR-BLK
LED Floodlight (X2 + 1 Driver)	3	LED-FLOOD-ARM-BDLK
Spot Light Clamp For Modulate	6	US903



Modulate™ cupboard - door with handle (without lock)



Modules join tool-free and without any connecting parts

The ease of assembly of the range allows for reconfigurable and reusable solutions: mix and match structures in an instant!

Modulate™ Stand 24m²



Material	Aluminium
Tube	30mm Ø
Assembly	Tool-free push-button connectors
Graphic area	Double-sided
Graphic attachment	Zipped tension-fit graphic

Modulate 800w x 2400h Squared Corners	1	MOD-S-824-SQ
Modulate 1800w x 2400h Squared Corners	2	MOD-S-1824-SQ
Modulate 2000w x 2400h Squared Corners	3	MOD-S-2024-SQ
Modulate Door 800w x 2400h Squared Corners	1	MOD-S-DOOR-824-SQ
Modulate Slope 2	1	MOD-SS-824-02
Half Foot (Pair)	3	MOD-HALF-FOOT-P
Accent 05 - With TV Bracket	1	FMLT-WBWA-05-TVH
Modulate Magnetic Counter	1	FORM-MOD-CNTR
Modulate Counter Shelf	1	FORM-MOD-CNTR-02
Illuminova 125mm Hanging 2500x1000	1	ILLNOH-125-25x10
LED Floodlight (X2 + 1 Driver)	3	LED-FLOOD-ARM-BDLK
Spot Light Clamp For Modulate	6	US903
Zed-Up Lite A4	1	AS315-002



Optional Spot
LED-FLOOD-ARM-BDLK

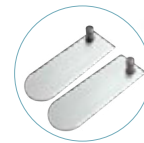

Half feet
Twist & Lock
MOD-HALF-FOOT-P



Accessorise with a
Modulate™ counter



VECTOR



Vector

Visual marketing for every budget

Whether wall mounted or free-standing, the diverse range of Vector aluminium profiles provides a solution for every need and every budget.

Vector offers optimal visual impact and original designs that can be adapted to any event: showrooms, point of sale, exhibitions, museums and many others.

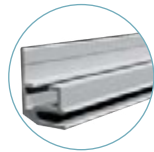

Quick Fix 20 mm

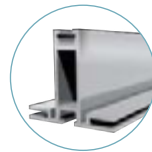

50 mm

Illuminova™ brings your Vector stand to light

Add eye-catching Illuminova™ lightbox modules to your Vector display stand. Available in 4 standard LED modules, (I, J, P, and Q), both systems can be combined to create a striking mix of simplicity and illumination to your exhibition stand.

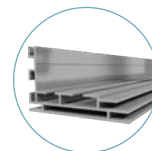

75 mm LED

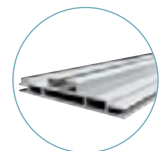

100 mm LED

Anodised aluminium profiles

The Vector and Illuminova™ modules are available in a range of aluminium profiles to suit each application. For more information, please consult the table below.

VECTOR
VECTOR
illumiNOVA
illumiNOVA

VECTOR	Wall mounted	Free-standing	Illuminated	Double-sided	Premium range	Various colours
20 mm	x					x
50 mm		x		x	x	
75 mm LED	x	x	x		x	x
100 mm LED		x	x	x		

Vector Modules

An ultra-compact solution

From free-standing textile walls to exhibition stands, the Vector range offers a versatile and adaptable solution for all your events. The Vector frame system with stretched fabric covering is one of the simplest communication solutions on the market, particularly in a stand environment. Scalable, reconfigurable, ultra-portable: go from a 9m² to a 15m² stand with ease. Easily create stands of all sizes and shapes and accessorise them with spotlights, counters, document holders, and anything else you need to display.

A compact solution for portability and optimised storage

Choose the Vector Modules:

- 50 mm aluminium profiles
- Different modules: walls, arches, LEDs, storage...
- Packaged in numbered sections of 1250 mm
- Delivered in a cardboard box with assembly instructions, accompanied by the visual of your choice
- In stock all year round
- Each module is already perforated on 4 sides and equipped with the necessary screws: easily assemble different modules together, one Allen key is the only tool you will need.
- Reconfigurable and reusable: store the stand at home in a small box (1350 x 400 x 300 mm)
- Excellent return on investment

Go from a 3m² stand to a 15m² stand in the blink of an eye!

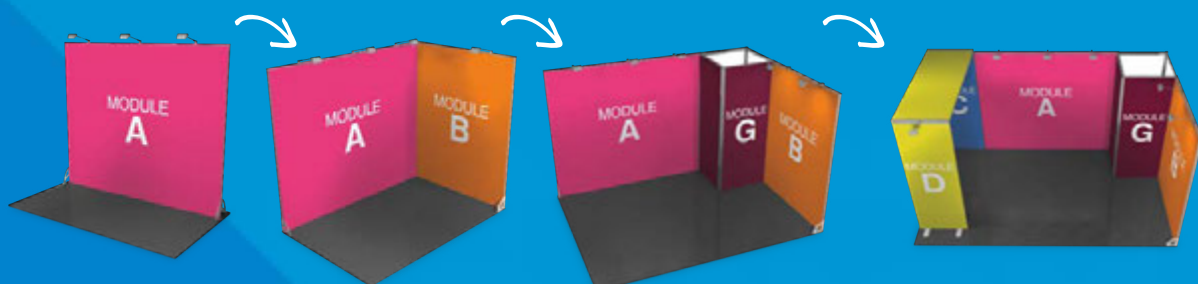

Vector Modules – Walls

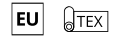

Material	Aluminium
Profile width	50mm
Profile Colour Tube	Anodised Silver
Assembly	Connectors assemble using Allen key
Graphic area	Single and double-sided
Graphic attachment	Silicone Edged Graphics (SEG)

Module A	MODULE-VFF-A	📏 2950(w) x 2500(h) x 50(d) mm
----------	--------------	--------------------------------



Module B	MODULE-VFF-B	📏 1950(w) x 2500(h) x 50(d) mm
----------	--------------	--------------------------------



Module C	MODULE-VFF-C	📏 950(w) x 2500(h) x 50(d) mm
----------	--------------	-------------------------------



Key

Module A		Module N	
Module B		Module O	
Module C		Module L	
Module M			

Module M	MODULE-VFF-M	@ 2850(w) x 2500(h) x 50(d) mm
----------	--------------	--------------------------------



Module N	MODULE-VFF-N	@ 1850(w) x 2500(h) x 50(d) mm
----------	--------------	--------------------------------



Module O	MODULE-VFF-O	@ 450(w) x 2500(h) x 50(d) mm
----------	--------------	-------------------------------



Module L	MODULE-VFF-L	@ 2800(w) x 2500(h) x 620(d) mm
----------	--------------	---------------------------------



Illuminova™ Modules



Material	Aluminium
Profile width	75mm and 100mm
Profile Colour Tube	Anodised Silver
Assembly	Connectors assemble using Allen key
Graphic area	Single and double-sided
Graphic attachment	Silicone Edged Graphics (SEG)
LED System	Pre-installed LED lighting



Module I	MODULE-VFF-I	950(w) x 2550(h) x 550(d) mm
----------	--------------	------------------------------



Module J	MODULE-VFF-J	950(w) x 2500(h) x 75(d) mm
----------	--------------	-----------------------------



Module P	MODULE-VFF-P	1850(w) x 2500(h) x 100(d) mm
----------	--------------	-------------------------------



Module Q	MODULE-VFF-Q	1850(w) x 1000(h) x 100(d) mm
----------	--------------	-------------------------------



Consider adding 2 x 1000mm square posts



Key

Module I		Module Q	
Module J		Module D	
Module P		Module H	

Post Module

EU

Material	Aluminium
Profile width	50mm
Profile Colour Tube	Anodised Silver
Assembly	Connectors assemble using Allen key, Screw-in strips



Module E	MODULE-VFF-E	50(w) x 2500(h) mm x 50(d)
----------	--------------	----------------------------

Modules Vector - Arches

EU TEX

Material	Aluminium
Profile width	50 mm
Profile Colour Tube	Anodised Silver
Assembly	Connectors assemble using Allen key
Graphic area	Single and double-sided
Graphic attachment	Silicone Edged Graphics (SEG)

Module D	MODULE-VFF-D	2550(h) x 950(l) x 2600(p) mm
----------	--------------	-------------------------------



Module H	MODULE-VFF-H	2550(h) x 950(l) x 2600(p) mm
----------	--------------	-------------------------------



Vector Modules - Storage

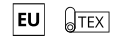

Material	Aluminium
Profile width	50 mm
Profile Colour Tube	Anodised Silver
Assembly	Connectors assemble using Allen key
Graphic area	Single and double-sided
Graphic attachment	Silicone Edged Graphics (SEG)

Module F - door and extension hardware	MODULE-VFF-F-2	⊕ 2500(h) x 950(l) x 50(p) mm Extension: 545 (h) x 950 (l) mm. Door: 1930 (h) x 940 (l) mm
--	----------------	--



Module G - corner storage room hardware	MODULE-VFF-G-2	⊕ 2500(h) x 1050(l) x 1050(d) mm
---	----------------	----------------------------------



Module G3 - storage room hardware	MODULE-VFF-G3-2	⊕ 2500(h) x 1050(l) x 1050(d) mm
-----------------------------------	-----------------	----------------------------------

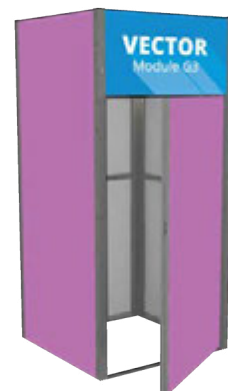
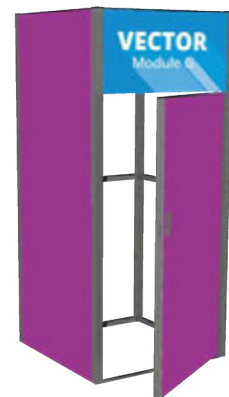

Vector Modules Extensions



Material	Aluminium
Profile width	50mm
Profile Colour	Anodised Silver
Assembly	Connectors assemble using Allen key
Graphic area	Single or double-sided
Graphic attachment	Silicone Edged Graphics (SEG)

Module K	MODULE-VFF-K	⊕ 1050(w) x 1000(h) x 1050(d) mm
----------	--------------	----------------------------------



Key

Module F	■	Module G3	■
Module G	■	Module K	■



Vector standard stand designs

This section showcases examples of various pre-configured Vector Stands that can be achieved using the various Vector hardware and ancillaries.

Vector Stand 6m²



Material	Aluminium
Profile width	50mm
Profile Colour	Anodised Silver
Assembly	Connectors assemble using Allen key
Graphic area	Single or double-sided
Graphic attachment	Silicone Edged Graphics (SEG)

Vector module B - 1950w x 2500h	2	MODULE-VFF-B
Vector module M - 2850w x 2500h	1	MODULE-VFF-M
Vector module E - post	2	MODULE-VFF-E
Quarter side feet (pair)	1	SLF1P
Formulate oval counter	1	FORM-OVAL-CNTR
LED exhibition light (x2 + 1 driver)	2	LED-EXHIB-ARM-BDLK



Possibility to add
LED Exhibition Light
Code : LED-EXHIB-ARM-BDLK



Angle foot
Code: SLF1P

Vector Stand 9m²

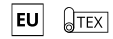

Material	Aluminium
Profile width	50mm
Profile Colour	Anodised Silver
Assembly	Connectors assemble using Allen key
Graphic area	Single or double-sided
Graphic attachment	Silicone Edged Graphics (SEG)

Vector module B - 1950w x 2500h	2	MODULE-VFF-B
Vector module G3 - storage room	1	MODULE-VFF-G3-2
800mm shelf - white	2	LN320-800-WH
Fixing bracket for vector accessories (pair)	2	FX898-01
Shelf or TV fixing bracket beam	2	LN605-CUSTOM-L2
Quarter side feet (pair)	1	SLF1P
Fastframe™ counter	1	FF-COUNTER-BLK
LED exhibition light (x2 + 1 driver)	2	LED-EXHIB-ARM-BDLK



Scalable stands go from 9m² to 15m²



Possibility to add LED Exhibition Light
Code : LED-EXHIB-ARM-BDLK



Angle foot
Code: SLF1P



Return with lock
and key set

Vector Stand 12m²



Material	Aluminium
Profile width	50mm
Profile Colour	Anodised Silver
Assembly	Connectors assemble using Allen key
Graphic area	Single or double-sided
Graphic attachment	Silicone Edged Graphics (SEG)



Vector module C - 950w x 2500h	2	MODULE-VFF-C
Vector module B - 1950w x 2500h	1	MODULE-VFF-B
Vector module G3 - storage room	2	MODULE-VFF-G3-2
Vector module K - extension	2	MODULE-VFF-K
Formulate accent 15 for Vector	2	FMLT-WL15-V
Quarter side feet (pair)	1	SLF1P
Illumigo counter	1	ILLGO-COUNTER
LED exhibition light (x2 + 1 driver)	2	LED-EXHIB-ARM-BDLK

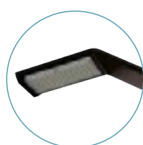

Possibility to add
LED Floodlight
Code: LED-EXHIB-ARM-BDLK



Return with lock
and key set

Vector Stand 15m²

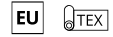

Material	Aluminium
Profile width	50mm
Profile Colour	Anodised Silver
Assembly	Connectors assemble using Allen key
Graphic area	Single or double-sided
Graphic attachment	Silicone Edged Graphics (SEG)

Vector module C - 950w x 2500h	3	MODULE-VFF-C
Vector module B - 1950w x 2500h	2	MODULE-VFF-B
Vector module A - 2950w x 2500h	1	MODULE-VFF-A
Vector module F - door + extension	1	MODULE-VFF-F-2
Vector module E - post	4	MODULE-VFF-E
Vector module H - radius arch	1	MODULE-VFF-H
TV bracket	1	LN124
Fixing bracket for Vector accessories (pair)	1	FX898-01
Shelf or TV fixing bracket beam	2	LN605-CUSTOM-L2
Quarter side feet (pair)	1	SLF1P
Insta LED counter	1	INSTA-CNTR-BLK
LED exhibition light (x2 + 1 driver)	3	LED-EXHIB-ARM-BDLK

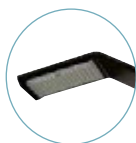

Possibility to add LED Floodlight
Code: LED-EXHIB-ARM-BDLK



Square post to create 90° angles



Return with lock and key set

Vector Stand 18m²

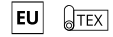

Material	Aluminium
Profile width	50mm
Profile Colour	Anodised Silver
Assembly	Connectors assemble using Allen key
Graphic area	Single or double-sided
Graphic attachment	Silicone Edged Graphics (SEG)

Vector module B - 1950w x 2500h	2	MODULE-VFF-B
Vector module A - 2950w x 2500h	1	MODULE-VFF-A
Vector module G3 - storage room	1	MODULE-VFF-G3-2
Quarter side feet (pair)	1	SLF1P
Insta LED counter	1	INSTA-CNTR-BLK
LED exhibition light (x2 + 1 driver)	3	LED-EXHIB-ARM-BDLK



Silicone Edged Graphics



Return with lock and key set

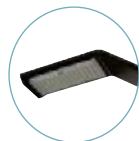

Possibility to add LED Floodlight
Code: LED-EXHIB-ARM-BDLK

Vector Stand 24m²



Material	Aluminium
Profile width	50mm
Profile Colour	Anodised Silver
Assembly	Connectors assemble using Allen key
Graphic area	Single or double-sided
Graphic attachment	Silicone Edged Graphics (SEG)

Vector module O - 450w x 2500h	1	MODULE-VFF-O
Vector module C - 950w x 2500h	3	MODULE-VFF-C
Vector module N - 1850w x 2500h	2	MODULE-VFF-N
Vector module B - 1950w x 2500h	1	MODULE-VFF-B
Illuminova module P - 1850w x 2500w	1	MODULE-VFF-P
Illuminova module Q - 1850w x 1000h	1	MODULE-VFF-Q
Vector module F - door + extension	1	MODULE-VFF-F-2
Vector module E - post	6	MODULE-VFF-E
Vector module D - arch	1	MODULE-VFF-D
TV bracket	1	LN124
Fixing bracket for Vector accessories (pair)	2	FX898-01
Shelf or TV fixing bracket beam	2	LN605-CUSTOM-L2
Fastframe™ counter	1	FF-COUNTER-BLK
LED exhibition light (x2 + 1 driver)	2	LED-EXHIB-ARM-BDLK



Square post to create 90° angles



Return with lock and key set



Vector free-standing module configurations and ancillaries

3m Wall



Material 50 mm aluminium profile frame
Graphic Fabric graphic with 3mm SEG

Ideal for creating large picture walls or partitions

Module A (x1)	MODULE-VFF-A
Flat Foot (unit) (x2)	LN155
Side Flat Feet (pair) (x1)	SLF4P



6m Wall



Module A (x2)	MODULE-VFF-A
Flat Feet (x4)	LN155
Side Flat Feet (pair) (x1)	SLF4P

Enhance engagement!
 Attach LED spotlights to your free-standing frames to make graphics bright and eye-catching

Assemble several modules to create very large picture walls



Stabilising feet
 For optimal stability of your structures, add feet at regular intervals.

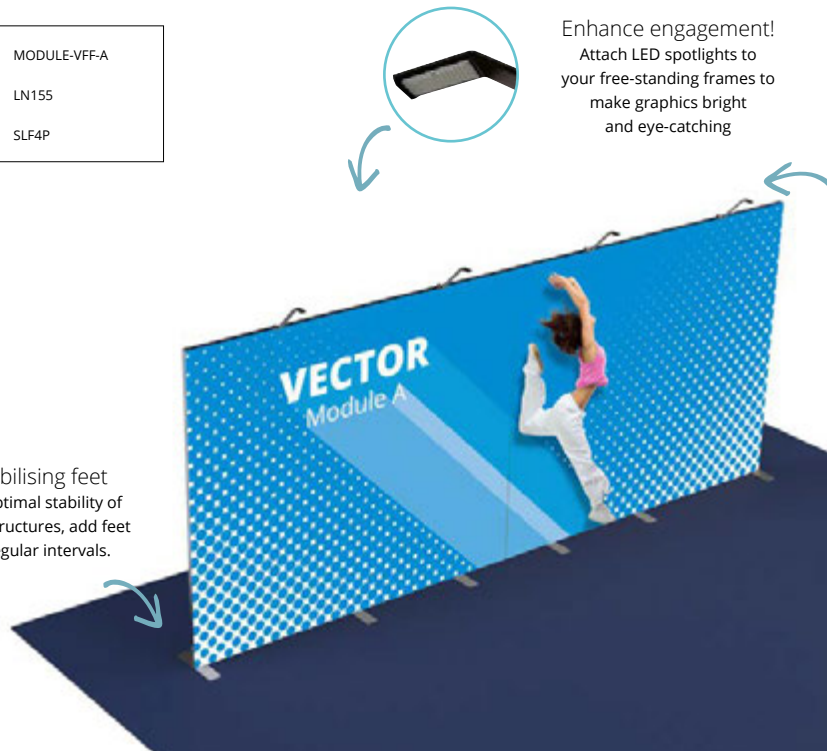
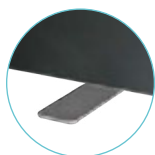

Custom Vector stands

The Vector range offers a versatile and adaptable solution for any event. The frame system is scalable and reconfigurable and is dressed with an optional custom printed stretched fabric graphic. The Vector range offers a versatile and adaptable solution for any event.

Vector Custom Stand 24m²

Material	Aluminium
Profile width	50mm
Profile colour	Anodised Silver
Assembly	Connectors assemble using Allen key
Graphic area	Single or double-sided
Graphic attachment	Silicone Edged Graphics (SEG)

Add a touch of originality to your VECTOR stand by integrating FORMULATE

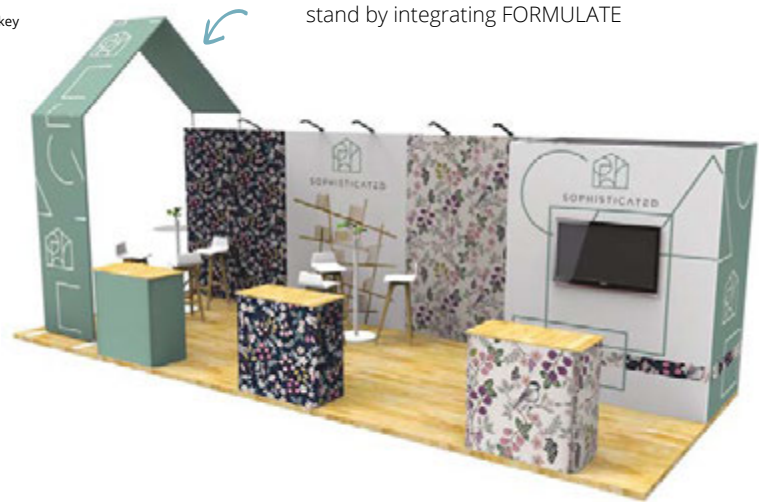

Vector Custom Stand 40m²

Material	Aluminium
Profile width	50mm
Profile colour	Anodised Silver
Assembly	Connectors assemble using Allen key
Graphic area	Single or double-sided
Graphic attachment	Silicone Edged Graphics (SEG)



Vector Custom Stand 40m²

Material	Aluminium
Profile width	50mm
Profile colour	Anodised Silver
Assembly	Connectors assemble using Allen key
Graphic area	Single or double-sided
Graphic attachment	Silicone Edged Graphics (SEG)



Vector Custom Stand 60m² - Design 1

Material	Aluminium
Profile width	50mm
Profile colour	Anodised Silver
Assembly	Connectors assemble using Allen key
Graphic area	Single or double-sided
Graphic attachment	Silicone Edged Graphics (SEG)



Vector Custom Stand 60m² - Design 2

Material	Aluminium
Profile width	50mm
Profile colour	Anodised Silver
Assembly	Connectors assemble using Allen key
Graphic area	Single or double-sided
Graphic attachment	Silicone Edged Graphics (SEG)

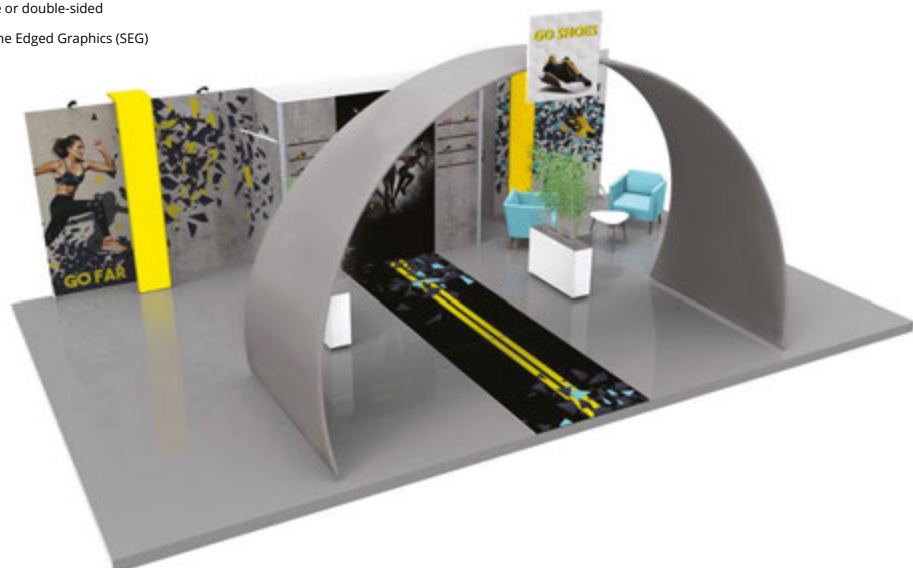

Vector Custom Stand 80m²

Material	Aluminium
Profile width	50mm
Profile colour	Anodised Silver
Assembly	Connectors assemble using Allen key
Graphic area	Single or double-sided
Graphic attachment	Silicone Edged Graphics (SEG)

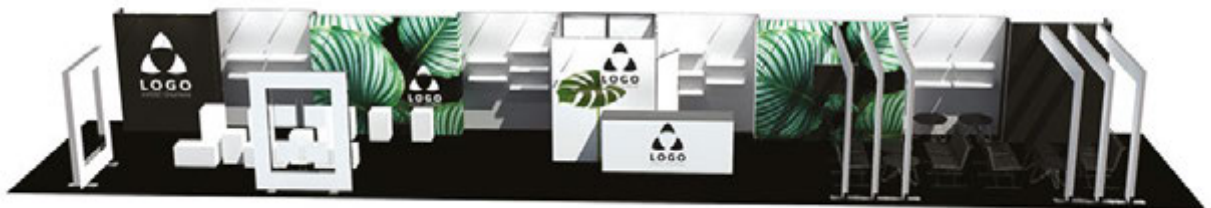

Vector Modules ancillaries

Quick-fix Mounting Bracket

For hanging frames on shell schemes

Mounting bracket | LN134



Quarter Side Feet (Pair)

SLF1P | 220(h) x 220(w) x 5(d) mm



Flat Foot for retail

Metal foot for free-standing frames
Available colour: Silver

FX295 | 7(h) x 180(w) x 550(d) mm



Flat Foot

Metal foot for free-standing frames

LN155 | 7(h) x 75(w) x 450(d) mm



Side Flat Feet (Pair)

SLF4P | 100(w) x 185(h) x 450(d) mm



Modular carrying bag

AB-MODULAR-01 | 340(w) x 1400(h) x 290(d) mm



Ancillaries

Dome Base (Single)

LN102 |  Ø 450 mm



Roll Of Magnetic Tape

EM303 | Polarity A-30m x 4 mm



Steel Tape

EM351 | 15m x 12,7 mm



LCD Screen Bracket

Mounting on post or crossbar

LN124 |  Screen 37" - 70" (94 - 177 cm)



Shelf - 800mm

LN320- |  38(h) x 300/600/800/1180(l) x 235(p) mm

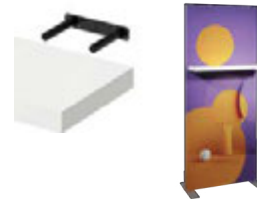

Vector Bracket (pair)

FX898-01



Shelf / TV Fixing Bracket Beam

LN605-CUSTOM-L2 |  45(h) x custom(l) x 15(p) mm



»» FASTFRAME™ your **innovative**
and **cost-effective** modular
Display Solution.



FASTFRAME™ is a unique, **sustainable** and **user-friendly** Display Solution,



More versatile than a pop-up

Highly configurable
Seamless graphics
Easy to change Silicone Edge Graphics (SEG)
Many applications



More flexible than a roller banner

Assembled in seconds
Lightweight, highly portable
One frame, multiple graphics
Single or double-sided graphics
Expandable, no joints
Washable stretch fabric
Cost savings through repeated use



More configurable than an exhibition stand

Expandable – add modules over time
Quick change design
Excellent space utilisation
Toolless construction
Seamless graphic overlay



Transform your space in seconds using **FASTFRAME™**



1. Folded state

The lightweight frame is pre-assembled in a convenient, portable carry bag.



2. Unfold

From its pre-assembled state, the frame can then be effortlessly unfolded and locked in place with a central support rod.



3. Components

Feet can be added if required to give additional rigidity to the frame.



4. Install graphics

Your graphics, available in a Standard or Premium finish, can then be applied to the fully assembled frame.

Sustainable exhibitions

With sustainability a key theme for event organisers and exhibitors alike, modular exhibition systems offer an environmentally conscious choice.

- » Made from aluminium, an infinitely recyclable material
- » Using polyester graphic materials which can be recycled multiple times
- » Graphics printed using water based inks
- » One system for multiple display applications



Enjoy **many benefits**, such as:



An efficient tool-less frame

Unit can be constructed and ready in a short amount of time.



Lightweight and ultra slim

Unit is highly portable, making travel and storage much easier.



Seamless graphic

Apply a single graphic to connected frames to create a large seamless display.



Sustainable

Multiple use, not single use.



Interchangeable graphics

Display multiple messages time and time again.

FASTFRAME™ utilises **Silicone Edge Graphics**

- » Fabric graphics are edged with a silicone strip which slots into the channel of the frame for easy installation
- » This is more cost-effective than alternative options and can be re-used multiple times
- » The graphics are printed using water based inks which is more eco-friendly
- » Seamless graphics can be applied to the connected frames for large displays
- » Graphics can be reproduced to deliver new messages

Polyester Stretch Graphics

Stretch textile fabric, 3mm silicone edge.

Black Back Graphics

Black back textile (black out), 3mm silicone edge.

Material	Aluminium
Profile width	40 mm
Profile Colour	Silver
Assembly	Tool-free
Graphic area	Single and Double-sided
Graphic attachment	Silicone Edged Graphics (SEG)
Application	Free-standing
Transport	Fastframe™ carry bag

FASTFRAME™

FASTFRAME™ 1000x500 - 2 Pack



Fastframe™	FF-100X50	1000(w) x 500(h) x 40(d) mm
Fastframe™ (Black back graphic)	G-FF-100X50-BB	1000(w) x 500(h)
Fastframe™ (Polyester stretch graphic)	G-FF-100X50-PS	1000(w) x 500(h)



Portable carry bag



Feet can be added if required



Silicone Edged Graphics (SEG)



FASTFRAME™ 1000x1000 - 2 Pack



Fastframe™	FF-100X100	1000(w) x 1000(h) x 40(d) mm
Fastframe™ (Black back graphic)	G-FF-100X100-BB	1000(w) x 1000(h)
Fastframe™ (Polyester stretch graphic)	G-FF-100X100-PS	1000(w) x 1000(h)



Portable carry bag



Feet can be added if required

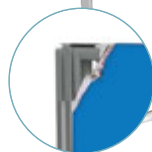

Silicone Edged Graphics (SEG)

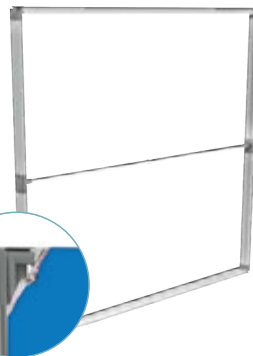

FASTFRAME™ 950x2000



Fastframe™	FF-95X200	Ⓞ 954(w) x 2007(h) x 400(d) mm
Fastframe™ (Black back graphic)	G-FF-95X200-BB	Ⓞ 950(w) x 2000(h)
Fastframe™ (Polyester stretch graphic)	G-FF-95X200-PS	Ⓞ 950(w) x 2000(h)



Portable carry bag



Includes 2 x feet

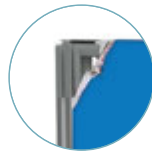

Silicone Edged
Graphics (SEG)



FASTFRAME™ 950x2400



Fastframe™	FF-95X240	Ⓞ 954(w) x 2407(h) x 400(d) mm
Fastframe™ (Black back graphic)	G-FF-95X240-BB	Ⓞ 950(w) x 2400(h)
Fastframe™ (Polyester stretch graphic)	G-FF-95X240-PS	Ⓞ 950(w) x 2400(h)



Portable carry bag



Includes 2 x feet



Silicone Edged
Graphics (SEG)



FASTFRAME™

FASTFRAME™ 950x2500



Fastframe™	FF-95X250	Ⓞ 954(w) x 2507(h) x 400(d) mm
Fastframe™ (Black back graphic)	G-FF-95X250-BB	Ⓞ 950(w) x 2500(h)
Fastframe™ (Polyester stretch graphic)	G-FF-95X250-PS	Ⓞ 950(w) x 2500(h)



Portable carry bag



Includes 2 x feet



Silicone Edged Graphics (SEG)



FASTFRAME™ 1000x2000



Fastframe™	FF-100X200	Ⓞ 1004(w) x 2007(h) x 400(d) mm
Fastframe™ (Black back graphic)	G-FF-100X200-BB	Ⓞ 1000(w) x 2000(h)
Fastframe™ (Polyester stretch graphic)	G-FF-100X200-PS	Ⓞ 1000(w) x 2000(h)



Portable carry bag



Includes 2 x feet



Silicone Edged Graphics (SEG)



FASTFRAME™ 1000x2400



Fastframe™	FF-100X240	Ⓞ 1004(w) x 2407(h) x 400(d) mm
Fastframe™ (Black back graphic)	G-FF-100X240-BB	Ⓞ 1000(w) x 2400(h)
Fastframe™ (Polyester stretch graphic)	G-FF-100X240-PS	Ⓞ 1000(w) x 2400(h)



Portable carry bag



Includes 2 x feet



Silicone Edged
Graphics (SEG)



FASTFRAME™ 1000x2500



Fastframe™	FF-100X250	Ⓞ 1004(w) x 2507(h) x 400(d) mm
Fastframe™ (Black back graphic)	G-FF-100X250-BB	Ⓞ 1000(w) x 2500(h)
Fastframe™ (Polyester stretch graphic)	G-FF-100X250-PS	Ⓞ 1000(w) x 2500(h)



Portable carry bag



Includes 2 x feet



Silicone Edged
Graphics (SEG)



FASTFRAME™ 1200x2400



Fastframe™	FF-120X240	📏 1204(w) x 2407(h) x 400(d) mm
Fastframe™ (Black back graphic)	G-FF-120X240-BB	📏 1200(w) x 2400(h)
Fastframe™ (Polyester stretch graphic)	G-FF-120X240-PS	📏 1200(w) x 2400(h)



Portable carry bag



Includes 2 x feet



Silicone Edged Graphics (SEG)

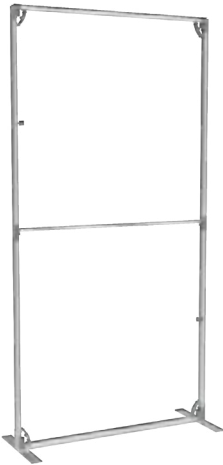

FASTFRAME™ Feet

Full Foot (Single)

FF-FF | 50(w) x 99(h) x 400(d) mm



Middle Full Foot (Single)

FF-MFF | 50(w) x 89(h) x 400(d) mm



Half Middle Foot (Single)

FF-HFM | 51(w) x 89(h) x 220(d) mm



Small Middle Foot (Single)

FF-SMF | 40(w) x 89(h) x 97(d) mm



Side Half Feet (Pair)

FF-SHF | 50(w) x 98(h) x 220(d) mm



FASTFRAME™ Connectors

45° Connector Kit - Top & Bottom

FF-45C | 45(w) x 108(h) x 95(d) mm



90° Connector Kit - Top & Bottom

FF-90C | Top 81.5(w) x 60.7(h) x 81.5(d) mm
Bottom 81.5(w) x 60.7(h) x 81.5(d) mm



FASTFRAME™ Connectors

90° Middle Connector Kit - Pair

FF-90MIC | 40(w) x 55(h) x 40(d) mm



90° Left Inside Connector Kit - Pair

FF-90LIC | 40(w) x 55(h) x 40(d) mm



90° Right Inside Connector Kit - Pair

FF-90RIC | 55(w) x 85(h) x 55(d) mm

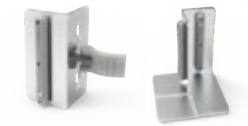

Arch Connector Kit - 4 Brackets

FF-ACC | 90(w) x 105(h) x 60(d) mm



Cross Connector Kit - Top & Bottom

FF-CC | Top 142(w) x 94.3(h) x 100.7(d) mm
Bottom 141.3(w) x 90(h) x 100.4(d) mm



T-Shape Connector Kit - Top & Bottom

FF-TC | Top 100.5(w) x 91(h) x 94.7(d) mm
Bottom 100(w) x 91.1(h) x 97.4(d) mm



Y Shape Connector Kit - Top & Bottom

FF-YC | Top 107(w) x 97.3(h) x 107(d) mm
Bottom 107(w) x 107(h) x 94.3(d) mm



FASTFRAME™ Connectors

2-Way Connector - Single

FF-2WC | 41(w) x 82(h) x 21(d) mm



4-Way Connector - Single

FF-4WC | 150(w) x 12.12(h) x 19.6(d) mm

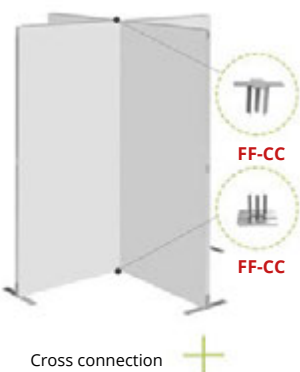
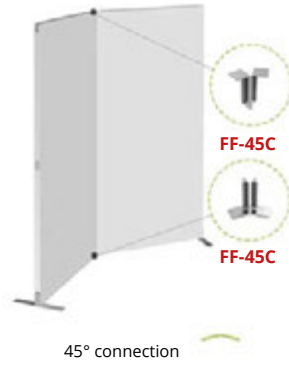
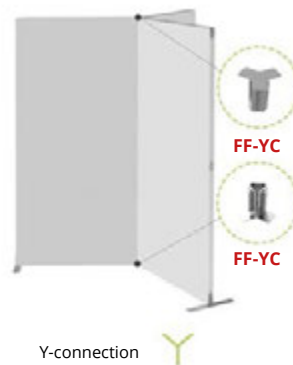
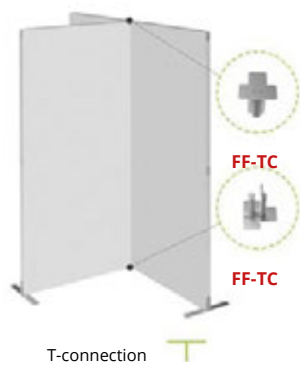
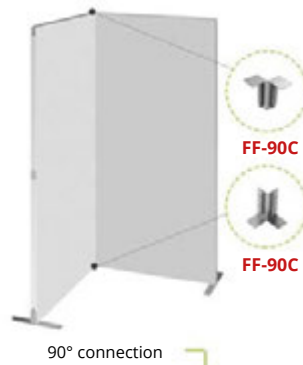
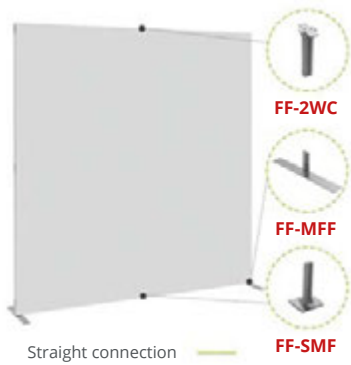

FASTFRAME™ Kits

Arch Brace Kit

FF-ABK | 171(w) x 7(h) x 42(d) mm

*for use with frames over 1000mm



Screen Mount Kit

FF-SMK | up to 10kg

* Maximum screen weight 10kg
VESA mount 200 x 200, 200 x 400, 300 x 300 and 400x400mm
Screen size from 26"- 65"
Only suitable for 1000mm width frame
Only suitable for use on an arch



Shelf Kit

FF-SK | 1020(w) x 30(h) x 252(d) mm

* Only suitable for 1000mm width frames
Maximum weight 5kg



Door Mount Bracket Kit

FF-DMB-1000

Add a handy storage unit to your Fastframe™ display stand with the Door Mount Bracket Kit. It contains all the required connectors to transform 1000mm width frames into a concealed storage area*

*Frames sold separately



Wheeled Bag

FF-WB | 1415(w) x 390(h) x 244(d) mm

* Holds up to x 4, 1200 x 2400 Fastframe with graphics



FASTFRAME™

FASTFRAME™ Stand 6m²



Quick and easy to assemble and disassemble. Add energy saving LED lighting to illuminate the back walls for more standout.

Material	Aluminium and ABS/nylon
Profile width	40mm
Profile colour	Silver
Assembly	Pre-assembled folding
Graphic area	Single or double-sided
Graphic attachment	Silicone Edged Graphics (SEG)

Fastframe™ 950 X 2400 (With Feet)	7	FF-95X240
90° Connector Kit - Top & Bottom	2	FF-90C
Side Half Feet (Pair)	1	FF-SHF
2 - Way connector	4	FF-2WC
Small Middle Foot	4	FF-SMF
LED Exhibition Light (X2 + 1 Driver)	2	LED-EXHIB-ARM-BDLK
Fastframe™ Counter	1	FF-COUNTER-BLK



Portable carry bag



Feet can be added if required



Silicone Edged Graphics (SEG)

Graphics available in black back or polyester stretch, seamless graphics are available

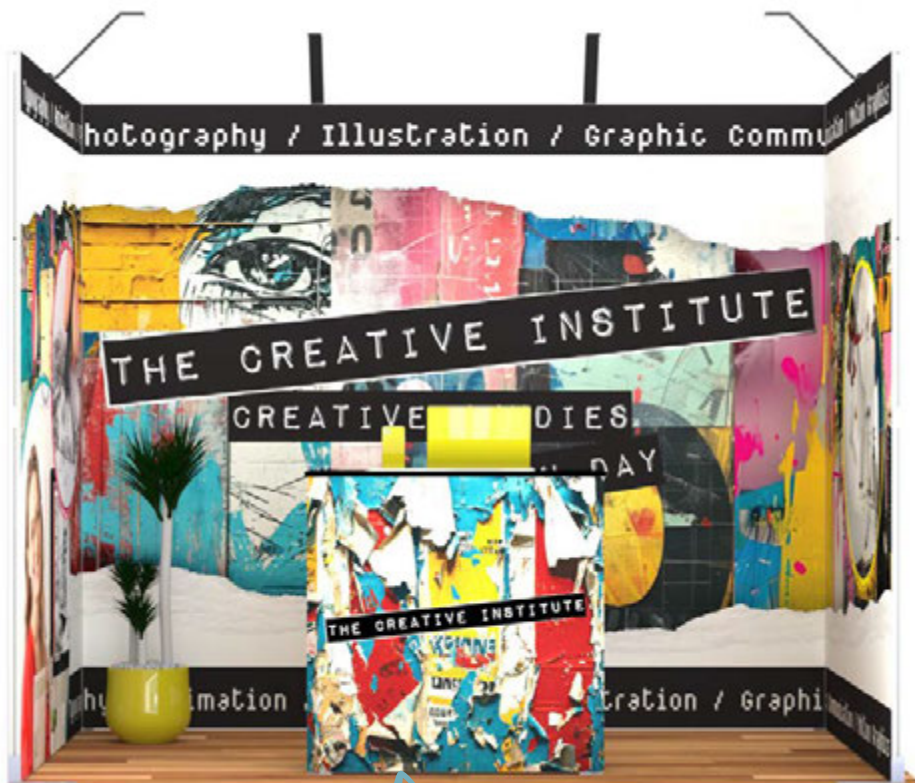

FASTFRAME™ Counter

FASTFRAME™ Stand 9m²



Material	Aluminium and ABS/nylon
Profile width	40mm
Profile colour	Silver
Assembly	Pre-assembled folding
Graphic area	Single or double-sided
Graphic attachment	Silicone Edged Graphics (SEG)

Fastframe™ 950 X 2400 (With Feet)	4	FF-95X240
Fastframe™ 1000 X 2400 (With Feet)	4	FF-100X240
Small Middle Foot	3	FF-SMF
Side Half Feet (Pair)	1	FF-SHF
2 - Way connector	2	FF-2WC
Door Mount Bracket Kit	1	FF-DMB-1000
LED Exhibition Light (X2 + 1 Driver)	2	LED-EXHIB-ARM-BDLK
Fastframe™ Counter	1	FF-COUNTER-BLK



Portable carry bag



Feet can be added if required



Silicone Edged Graphics (SEG)

Graphics available in black back or polyester stretch, seamless graphics are available



FASTFRAME™ Counter

Scalable stands go from 9m² to 15m²
Add FF-90C



FASTFRAME™ Stand 12m²



Material	Aluminium and ABS/nylon
Profile width	40mm
Profile colour	Silver
Assembly	Pre-assembled folding
Graphic area	Single or double-sided
Graphic attachment	Silicone Edged Graphics (SEG)

Fastframe™ 950 X 2400 (With Feet)	4	FF-95X240
Fastframe™ 1000 X 2400 (With Feet)	6	FF-100X240
Fastframe™ 1000 X 500 (With Feet)	1	FF-100X50
Small Middle Foot	3	FF-SMF
Side Half Feet (Pair)	1	FF-SHF
2 - Way Connector	3	FF-2WC
Full Foot Single	2	FF-FF
Door Mount Bracket Kit	1	FF-DMB-1000
Arch Connector Kit (4 Brackets)	1	FF-ACC
Shelf Kit	1	FF-SK
LED Exhibition Light (X2 + 1 Driver)	2	LED-EXHIB-ARM-BDLK
Fastframe™ Counter (Black)	1	FF-COUNTER-BLK



Portable carry bag

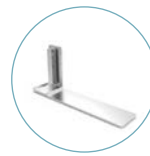

Feet can be added if required



Silicone Edged Graphics (SEG)

Graphics available in black back or polyester stretch, seamless graphics are available



FASTFRAME™ Counter

FASTFRAME™ Stand 15m²



Material	Aluminium and ABS/nylon
Profile width	40mm
Profile colour	Silver
Assembly	Pre-assembled folding
Graphic area	Single or double-sided
Graphic attachment	Silicone Edged Graphics (SEG)

Fastframe™ 950 X 2400 (With Feet)	4	FF-95X240
Fastframe™ 1000 X 2400 (With Feet)	8	FF-100X240
Fastframe™ 1000 X 2000mm (With Feet)	1	FF-100X200
Small Middle Foot	3	FF-SMF
Side Half Feet (Pair)	1	FF-SHF
2 - Way Connector	5	FF-2WC
Arch Connector Kit (4 Brackets)	1	FF-ACC
Arch Brace Kit	1	FF-ABK
Full Foot Single	2	FF-FF
Screen Mount Kit	1	FF-SMK
Door Mount Bracket Kit	1	FF-DMB-1000
LED Exhibition Light (X2 + 1 Driver)	3	LED-EXHIB-ARM-BDLK
Fastframe™ Counter	1	FF-COUNTER-BLK



Portable carry bag



Feet can be added if required



Silicone Edged Graphics (SEG)

Graphics available in black back or polyester stretch, seamless graphics are available



FASTFRAME™ Counter

FASTFRAME™ Stand 18m²



Material	Aluminium and ABS/nylon
Profile width	40mm
Profile colour	Silver
Assembly	Pre-assembled folding
Graphic area	Single or double-sided
Graphic attachment	Silicone Edged Graphics (SEG)



Fastframe™ 950 X 2400 (With Feet)	4	FF-95X240
Fastframe™ 1000 X 2400 (With Feet)	7	FF-100X240
Small Middle Foot	1	FF-SMF
Middle Half Foot	4	FF-HFM
Side Half Feet (Pair)	1	FF-SHF
2 - Way Connector	5	FF-2WC
Door Mount Bracket Kit	1	FF-DMB-1000
LED Exhibition Light (X2 + 1 Driver)	3	LED-EXHIB-ARM-BDLK
Fastframe™ Counter	1	FF-COUNTER-BLK



Portable carry bag

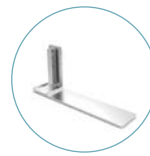

Feet can be added if required



Silicone Edged Graphics (SEG)

Graphics available in black back or polyester stretch, seamless graphics are available



FASTFRAME™ Counter

FASTFRAME™ Stand 24m²



Material	Aluminium and ABS/nylon
Profile width	40mm
Profile colour	Silver
Assembly	Pre-assembled folding
Graphic area	Single or double-sided
Graphic attachment	Silicone Edged Graphics (SEG)

Fastframe™ 950 X 2400 (With Feet)	2	FF-95X240
Fastframe™ 1000 X 2400 (With Feet)	13	FF-100X240
Small Middle Foot	2	FF-SMF
Side Half Feet (Pair)	1	FF-SHF
2 - Way Connector	3	FF-2WC
Door Mount Bracket Kit	1	FF-DMB-1000
Arch Connector Kit (4 Brackets)	1	FF-ACC
Arch Brace Kit	1	FF-ABK
Screen Mount Kit	1	FF-SMK
LED Exhibition Light (X2 + 1 Driver)	3	LED-EXHIB-ARM-BDLK
Fastframe™ Counter	1	FF-COUNTER-BLK



Portable carry bag



Feet can be added if required



Silicone Edged Graphics (SEG)

Graphics available in black back or polyester stretch, seamless graphics are available



FASTFRAME™ Counter





Arena Structures

Arena Gantry structures for your stand

These 25mm diameter aluminium tubes have been assembled and welded into sections of various sizes to form the basis of an imposing and solid architecture.

A wide range of sections are available to make this solution compatible with your project requirements. With 13 components in various lengths and designs, you can create the right structure for you, and your chosen mode of transport.

Simple, tool-free assembly

Simple assembly - sections are connected using the supplied bolt and wing-nut fixings, and no tools are required. The double-sided graphics are attached to the gantry using a bungee cord. Create maximum brand visibility using sections up to 6m long without the need for reinforcement.

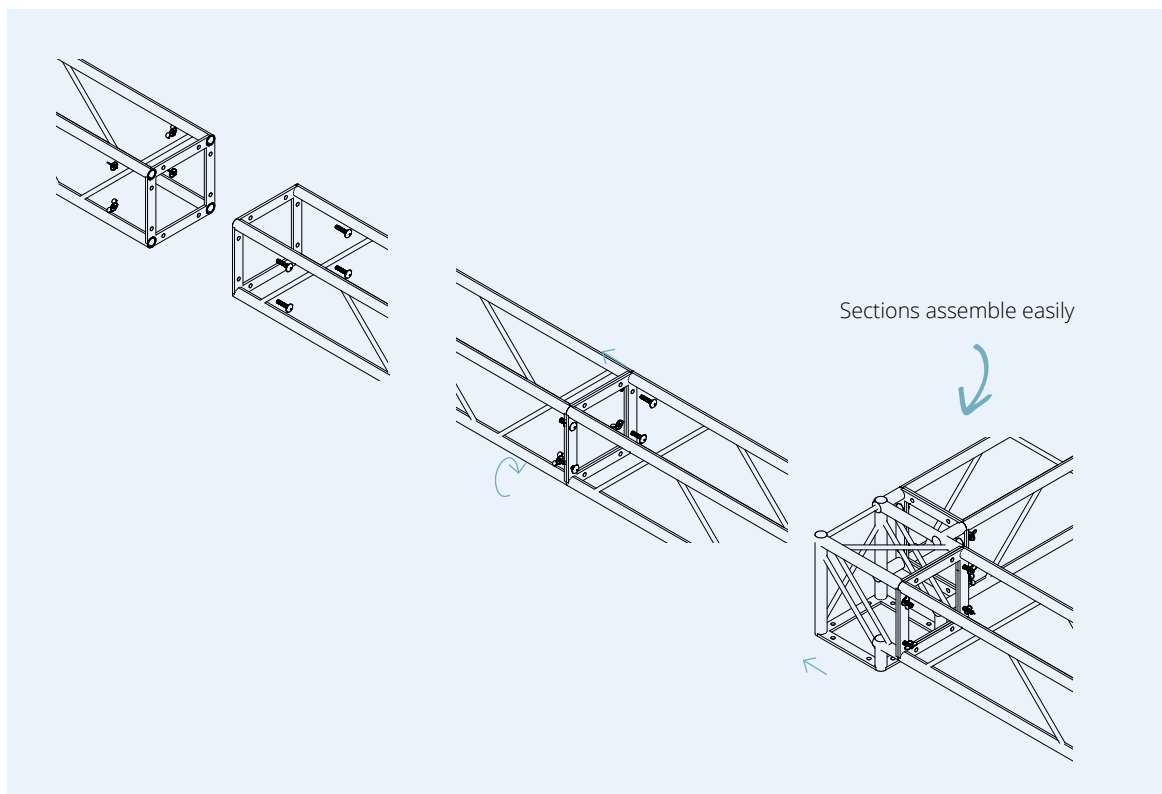

Arena components

Arena Straight Sections

The Arena Straight Sections are available in a variety of lengths, they are strong but lightweight with a natural silver grey finish. The system is quick and easy to assemble using bolt and wing-nut fixings. This aluminium tubular system is both modular and scalable, where different sections can be assembled and reused according to the needs of each project. The structure can then be dressed with interchangeable UV printed PVC graphics.

UT-S250	Section 250mm
UT-S500	Section 500mm
UT-S750	Section 750mm
UT-S1000	Section 1000mm
UT-S1250	Section 1250mm
UT-S1500	Section 1500mm
UT-S2000	Section 2000mm



Arena Junction Sections

The Arena Junction Sections are available in a variety of configurations including: 3-way T-junction, 4-way corner junction. The choice of sections enables a custom build design for your application to create a modular and scalable system. The structure can then be dressed with interchangeable UV printed PVC graphics.



90° angle 2 connections
UT-C21



Corner connection
3 connections
UT-C30

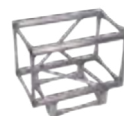

T-junction 3 connections
UT-C35

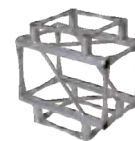

T-junction 4 connections
UT-C40



4-Way corner connector
UT-C41



Foot 250mm
UT-BS250

Arena Gantry stand designs

Arena Custom Stand 16m²

Material	Aluminium
Colour	Anodised Silver
Graphic area	Single or double-sided
Graphic attachment	Bungee fixings
Graphic option	Vinyl



Arena Custom Stand 36m²

Material	Aluminium
Colour	Anodised Silver
Graphic area	Single or double-sided
Graphic attachment	Bungee fixings
Graphic option	Vinyl

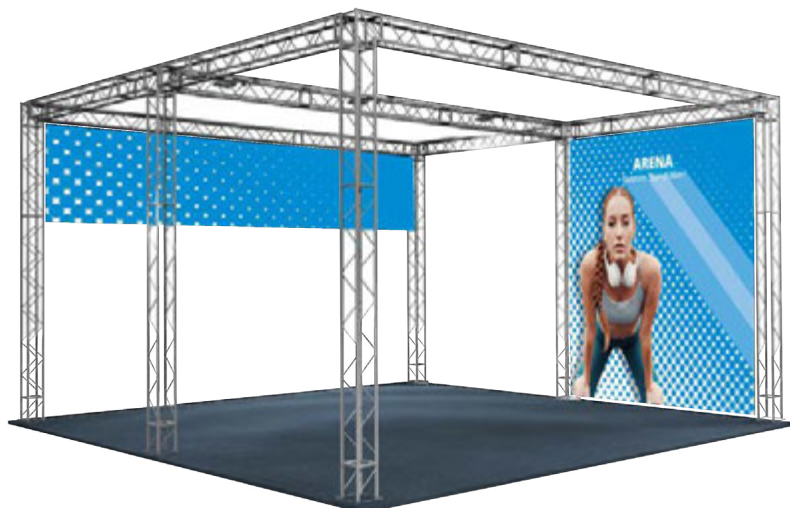

Arena Gantry free-standing design

Arena Custom Structure

Material	Aluminium
Colour	Anodised Silver
Graphic area	Single or double-sided
Graphic attachment	Bungee fixings
Graphic option	Vinyl



Arena Hanging Structure

The Arena hanging structure is a tubular aluminium stage structure used as a light bridge or suspended sign with 6m sides to draw attention to your brand.

Material	Aluminium
Colour	Anodised Silver
Graphic area	Single or double-sided
Graphic attachment	Bungee fixings
Graphic option	Vinyl

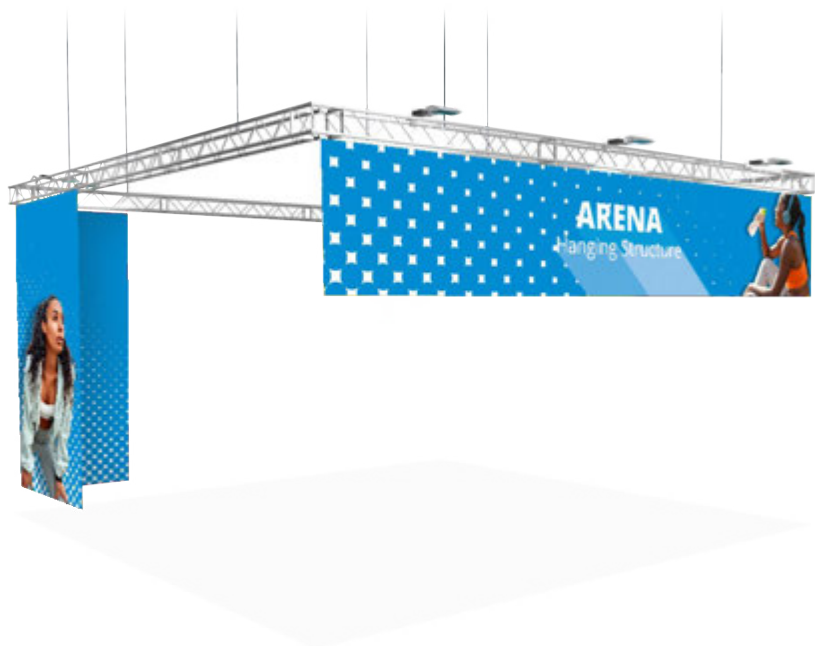

Hanging structures

Formulate suspended signs have been specially designed to allow for easy and safe installation. The lightweight aluminium tubular structure makes them ideal for use on exhibition stands, in shopping arcades or in high traffic areas.

Formulate Square Hanging Structure



Material	Aluminium tubes
Tube	Ø 30 mm
Assembly	Push-fit button
Shape	Square
Graphic area	Double-sided
Graphic attachment	Zipped tension fabric graphic
Application	Suspended pitons included, Slings not included
Availability	Basic range - in stock

Square Formulate 800	FORM-SQU-80	⊗ 1500(w) x 800(h) x 1500(d) mm
Square Formulate 1000	FORM-SQU-100	⊗ 3000(w) x 1000(h) x 3000(d) mm
Square Formulate 1500	FORM-SQU-150	⊗ 4500(w) x 1500(h) x 4500(d) mm



Formulate Circular Hanging Structure



Material	Aluminium tubes
Tube	Ø 30 mm
Assembly	Push-fit button
Shape	Circle
Graphic area	Double-sided
Graphic attachment	Zipped tension fabric graphic
Application	Suspended pitons included, Slings not included
Availability	Basic range - in stock

Circular Formulate 800	FORM-RNG-80	⊗ 1500(w) x 800(h) x 1500(d) mm
Circular Formulate 1000	FORM-RNG-100	⊗ 3000(w) x 1000(h) x 3000(d) mm
Circular Formulate 1500	FORM-RNG-150	⊗ 4500(w) x 1500(h) x 4500(d) mm



Formulate Rectangular Hanging Structure



Material	Aluminium tubes
Tube	Ø 30 mm
Assembly	Push-fit button
Shape	Rectangle
Graphic area	Double-sided
Graphic attachment	Zipped tension fabric graphic
Application	Suspended pitons included, Slings not included
Availability	Made to order

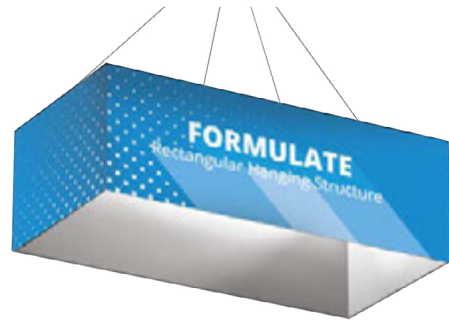

Formulate Rectangle 250	FORM-RTG-M100	Ⓞ 2500(w) x 1000(h) x 1200(d) mm
Formulate Rectangle 350	FORM-RTG-L100	Ⓞ 3500(w) x 1000(h) x 2500(d) mm
Formulate Rectangle 500	FORM-RTG-XL120	Ⓞ 5000(w) x 1200(h) x 2500(d) mm

Formulate Flat Panel Hanging Structure



Material	Aluminium tubes
Tube	Ø 30 mm
Assembly	Push-fit button
Shape	Rectangle
Graphic area	Double-sided
Graphic attachment	Zipped tension fabric graphic
Application	Suspended pitons included, Slings not included
Availability	Made to order

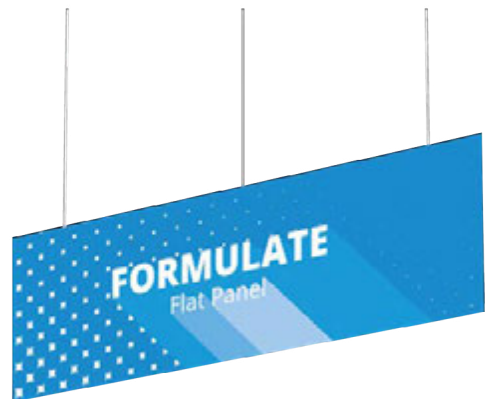

Formulate Panel 250	FORM-FLT-M100	Ⓞ 2500(w) x 1000(h) x 30(d) mm
Formulate Panel 350	FORM-FLT-L100	Ⓞ 3500(w) x 1000(h) x 30(d) mm
Formulate Panel 500	FORM-FLT-XL120	Ⓞ 5000(w) x 1200(h) x 30(d) mm

Display Backwalls create a dramatic backdrop to events, presentations, product demonstrations, pop-up shops or window displays.

Ideal for smaller spaces, or as large static advertising boards in public spaces such as museums, reception areas, public transportation hubs and other large spaces.





Display Backwalls

Backwalls can be configured in a variety of ways, based on the application, with each offering a different method of construction, illumination and use.

Pop-up backwalls

Impact Pop-up Straight



A great entry level display backwall that is perfect for use at an exhibition, event or for a demonstration backdrop. Frames are available in a variety of widths, and are quick and easy to deploy using the self-locating locking arms. Magnetic tape attaches to the back of the graphic panels enabling them to be attached directly to the mag bars which are mounted to the frames.

Material	Aluminium structure, plastic connectors
Assembly	Magnetic connectors
Shape	Straight
Graphic area	Single-sided (with or without D-ends) / double-sided (optional)
Graphic attachment	Mag bars, hangers and kickers
Application	Free-standing

3x2 Straight	IMP-3X2S	Ⓢ 1970(w) x 2225(h) x 306(d) mm
3x3 Straight	IMP-3X3S	Ⓢ 2700(w) x 2225(h) x 306(d) mm
3x4 Straight	IMP-3X4S	Ⓢ 3435(w) x 2225(h) x 306(d) mm

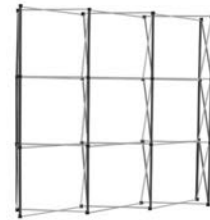

Magnetic bars



Magnetic Locking arms



Hook-over graphic attachment

Impact Pop-up Straight Bundle



Impact Pop-up straight bundles are a great entry level display backwall kit that contains everything you will need to get you up and running at a show, event or demonstration - they even come with a counter and lighting!

Material	Aluminium structure, plastic connectors
Assembly	Magnetic connectors
Shape	Straight
Graphic area	Single-sided (with or without D-ends) / double-sided (optional)
Graphic attachment	Mag bars, hangers and kickers
Application	Free-standing

3x2 Straight	99-XX-106	Ⓢ 1970(w) x 2225(h) x 306(d) mm
3x3 Straight	99-XX-107	Ⓢ 2700(w) x 2225(h) x 306(d) mm
3x4 Straight	99-XX-108	Ⓢ 3435(w) x 2225(h) x 306(d) mm



Impact Pop-up Bundle

Impact Pop-up Kit



Carry bag

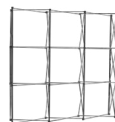

Straight or curved frame system



Hangers, kickers and mag bars



1x Roll of self-adhesive magnetic tape (EM301)



Zenith transport and counter base case



Thermoformed table top in beech



2x PS950-1000-LED-BDLK lights

Impact Pop-up Curved



A great entry level display backwall that is perfect for use at an exhibition, event or for a demonstration backdrop. Frames are available in a variety of widths, and are quick and easy to deploy using the self-locating locking arms. Magnetic tape attaches to the back of the graphic panels enabling them to be attached directly to the mag bars which are mounted to the frames.

Material	Aluminium structure, plastic connectors
Assembly	Magnetic connectors
Shape	Curved
Graphic area	Single-sided (with or without D-ends) / double-sided (optional)
Graphic attachment	Mag bars, hangers and kickers
Application	Free-standing

3x2 Curved	IMP-3X2C	Ⓞ 1930(w) x 2225(h) x 485(d) mm
3x3 Curved	IMP-3X3C	Ⓞ 2540(w) x 2225(h) x 685(d) mm
3x4 Curved	IMP-3X4C	Ⓞ 3070(w) x 2225(h) x 960(d) mm

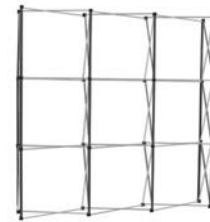

Magnetic bars



Magnetic Locking arms



Hook-over graphic attachment

Impact Pop-up Curved Bundle



Impact Pop-up curved bundles are a great entry level display backwall kit that contains everything you will need to get you up and running at a show, event or demonstration - they even come with a counter and lighting!

Material	Aluminium structure, plastic connectors
Assembly	Magnetic connectors
Shape	Curved
Graphic area	Single-sided (with or without D-ends) / double-sided (optional)
Graphic attachment	Mag bars, hangers and kickers
Application	Free-standing

3x2 Curved	99-XX-110	Ⓞ 1930(w) x 2225(h) x 485(d) mm
3x3 Curved	99-XX-071	Ⓞ 2540(w) x 2225(h) x 685(d) mm
3x4 Curved	99-XX-070	Ⓞ 3070(w) x 2225(h) x 960(d) mm



Impact Pop-up Bundle

Impact Pop-up Kit  Carry bag	 Straight or curved frame system	 Hangers, kickers and mag bars	 1x Roll of self-adhesive magnetic tape (EM301)	 Zenith transport and counter base case	 Thermoformed table top in beech	 2x PS950-1000-LED-BDLK lights
--	--	--	---	--	--	--

Quick+ Straight Kit



The premium Quick+ Straight display backwall is a full magnetic system that can be used single or double-sided. Use with optional interchangeable, vibrant UV printed PVC graphics. Deploys tool-free in seconds straight out of the supplied protective padded bag giving you a brilliant backwall display for your event or shell scheme. Quick+ displays are also available in a curved display and come in 3 different sizes.

Material	Aluminium structure, plastic connectors
Assembly	Magnetic connectors
Shape	Straight
Graphic area	Single-sided (with or without D-ends) / double-sided (optional)
Graphic attachment	Mag bars, hangers and kickers
Application	Free-standing

3x2 Straight	WH222-S-CA	Ⓞ 1970(w) x 2225(h) x 306(d) mm
3x3 Straight	WH223-S-CA	Ⓞ 2700(w) x 2225(h) x 306(d) mm
3x4 Straight	WH224-S-CA	Ⓞ 3435(w) x 2225(h) x 306(d) mm



Square end magnetic bars



Magnetic locking arms



Magnetic hanger

Quick+ Curved Kit



The premium Quick+ Curved display backwall is a full magnetic system that can be used single or double-sided. Use with optional interchangeable, vibrant UV printed PVC graphics. Deploys tool-free in seconds straight out of the supplied protective padded bag giving you a brilliant backwall display for your event or shell scheme. Quick+ displays are also available in a straight display and come in 3 different sizes.

Material	Aluminium structure, plastic connectors
Assembly	Magnetic connectors
Shape	Curved
Graphic area	Single-sided (with or without D-ends) / double-sided (optional)
Graphic attachment	Mag bars, hangers and kickers
Application	Free-standing

3x2 Curved	WH222-C-CA	Ⓞ 1930(w) x 2225(h) x 485(d) mm
3x3 Curved	WH223-C-CA	Ⓞ 2540(w) x 2225(h) x 685(d) mm
3x4 Curved	WH224-C-CA	Ⓞ 3070(w) x 2225(h) x 960(d) mm



Square end magnetic bars



Magnetic locking arms



Magnetic hanger



Quick+ Straight Bundle



The Premium Quick+ Straight Display Bundle includes the full magnetic display backwall kit which can be used single or double-sided, the unique Zenith transit case which converts to a counter and two PS950-1000 LED lights. Use with optional interchangeable, vibrant UV printed PVC graphics. Deploys tool-free in seconds, giving you a brilliant backwall display for your event or shell scheme. Quick+ displays are also available in a curved display bundle and come in 3 different sizes.

Material	Aluminium structure, plastic connectors
Assembly	Magnetic connectors
Shape	Straight
Graphic area	Single-sided (with or without D-ends) / double-sided (optional)
Graphic attachment	Mag bars, hangers and kickers
Application	Free-standing

3x2 Straight	99-XX-101Q	Ⓞ 1970(w) x 2225(h) x 306(d) mm
3x3 Straight	99-XX-102Q	Ⓞ 2700(w) x 2225(h) x 306(d) mm
3x4 Straight	99-XX-103Q	Ⓞ 3435(w) x 2225(h) x 306(d) mm



Quick+ Bundle

Quick+ Kit



Padded nylon carry bag



Quick+ Structure Straight / Curved



Hangers, kickers and mag bars



1x Roll of self-adhesive magnetic tape (EM301)



Zenith transport and counter base case



Thermoformed table top in beech



2x PS950-1000-LED-BDLK lights

Quick+ Curved Bundle



The Premium Quick+ Curved Display Bundle includes the full magnetic display backwall kit which can be used single or double-sided, the unique Zenith transit case which converts to a counter and two PS950-1000 LED lights. Use with optional interchangeable, vibrant UV printed PVC graphics. Deploys tool-free in seconds, giving you a brilliant backwall display for your event or shell scheme. Quick+ displays are also available in a straight display bundle and come in 3 different sizes.

Material	Aluminium structure, plastic connectors
Assembly	Magnetic connectors
Shape	Curved
Graphic area	Single-sided (with or without D-ends) / double-sided (optional)
Graphic attachment	Mag bars, hangers and kickers
Application	Free-standing

3x2 Curved	99-XX-016Q	Ⓞ 1930(w) x 2225(h) x 485(d) mm
3x3 Curved	99-XX-017Q	Ⓞ 2540(w) x 2225(h) x 685(d) mm
3x4 Curved	99-XX-020Q	Ⓞ 3070(w) x 2225(h) x 960(d) mm



Quick+ Bundle

Quick+ Kit



Padded nylon carry bag



Quick+ Structure Straight / Curved



Hangers, kickers and mag bars



1x Roll of self-adhesive magnetic tape (EM301)



Zenith transport and counter base case



Thermoformed table top in beech



2x PS950-1000-LED-BDLK lights

Hop-up Impact Straight



Impact Hop-ups are simple lightweight interlocking frame structures that deploy in minutes. Complete with tension-fit graphics that can stay on even when packed away.

Material	Aluminium structure, plastic connectors
Assembly	Lock together with clips
Shape	Straight
Graphic area	Single-sided (with or without returns) or double-sided (optional)
Graphic attachment	Hook and loop
Application	Free-standing

3x2 quads	HUI3X2	Ⓞ 1525(w) x 2260(h) x 295(d) mm
3x3 quads	HUI3X3	Ⓞ 2260(w) x 2260(h) x 295(d) mm
3x4 quads	HUI3X4	Ⓞ 2995(w) x 2260(h) x 295(d) mm
3x5 quads	HUI3X5	Ⓞ 3730(w) x 2260(h) x 295(d) mm

Graphic stays on structure once packed down



Graphics attach with hook and loop fastener



Plastic connectors



Easy to transport



Wheeled carry bag

Ancillaries :

Stabilising feet (pair)	ES508	Ⓞ N/A
-------------------------	-------	-------

Hop-up Impact Curved



Impact Hop-ups are simple lightweight interlocking frame structures that deploy in minutes. Complete with tension-fit graphics that can stay on even when packed away.

Material	Aluminium structure, plastic connectors
Assembly	Lock together with clips
Shape	Curved
Graphic area	Single-sided (with or without returns)
Graphic attachment	Hook and loop
Application	Free-standing

3x3 quads	HOP-2-3X3-C	Ⓞ 2310(w) x 2270(h) x 570(d) mm
3x4 quads	HOP-2-3x4-C	Ⓞ 2950(w) x 2260(h) x 810(d) mm



Easy to transport

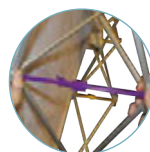

Plastic connectors



Graphics attach with hook and loop fastener



Wheeled carry bag

FASTFRAME™ Backwall Kit - 2 Metre



Fastframe™ Backwall Kit	FF-100X200 x2 FF-MFF x1	Ⓞ 2004(w) x 2007(h) x 400(d) mm
-------------------------	-------------------------	---------------------------------

Fastframe™ Backwall Kit



Portable carry bag



2 frames
1000 x 2000mm
includes
Standard feet



FF-MFF

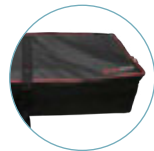

Optional wheeled bag



FASTFRAME™ Pop-up Kit



Fastframe™ Pop-up Kit	x3 FF-100X200 x2 FF-45C	Ⓞ 2690(w) x 2007(h) x 940(d) mm
-----------------------	-------------------------	---------------------------------

Dimensions based on configuration shown

Fastframe™ Pop-up Kit



Portable carry bag



3 frames
1000 x 2000mm
includes
Standard feet



2
45° connector
kit



Optional wheeled bag



FASTFRAME™ Backwall Kit - 3 Metre



Fastframe™ Backwall Kit	x3 FF-100X200, x2 FF-MFF	3004(w) x 2007(h) x 400(d) mm
-------------------------	--------------------------	-------------------------------

Fastframe™ Backwall Kit



Portable carry bag



3 frames
1000 x 2000mm
includes
standard feet

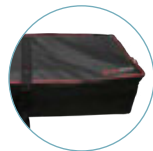

Optional wheeled bag



Fabric tube walls

Formulate LED Backwall



A bright, bold statement for indoor spaces.

This 3m illuminated backwall combines lightweight engineering with effortless assembly. Built from durable 50mm diameter aluminium tubing, each section is numbered for completely tool-free setup, making install a breeze even for first-timers.

Need flexibility? You've got it. The system can be downsized to 2m or even 1m, giving you multiple display options from a single kit.

Choose between SEG (silicone edge graphics) or a sock-style graphic depending on the look you're going for, both offer a smooth, wrinkle-free finish that keeps your message looking premium.

For lighting, the backwall features three polyester light blankets housing 12 LED strips, delivering even, bright illumination across the entire front surface. Paired with the SEG liner, your graphic stays perfectly lit edge-to-edge.

Material	Aluminium tubing
Tube	Ø 50 mm
Assembly	Push-fit / Allen key
Shape	Straight
Graphic area	Double-sided
Graphic attachment	SEG / SOCK
Application	Free-standing with feet (included)

2000 mm	FORM-STR-20	Ⓢ 3000(w) x 2200(h) x 400(d) mm
---------	-------------	---------------------------------



Bag



Numbered system for easy assembly

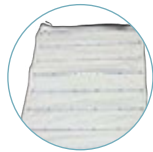

LED Blanket



LED Blanket



SEG Single Sided

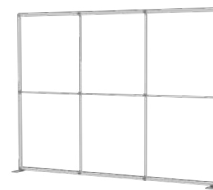

Double Sided Sock (Single Sided Illumination)

Formulate Straight



Formulate Straight backwalls are constructed of lightweight 30mm diameter push-fit aluminium tubing for tool-free simple deployment. Complete with optional double-sided dye-sublimated tension-fit fabric graphics that zip at the base to perfectly contour the shaped aluminium structure and maximize your brand message. Formulate displays offer a variety of great shapes with clean lines, ideal for creating picture backwalls or defining areas in rooms by screening or zoning.

Material	Aluminium tubing
Tube	Ø 30 mm
Assembly	Push-fit / Allen key
Shape	Straight
Graphic area	Double-sided
Graphic attachment	Zippered tension fabric graphic
Application	Free-standing with feet (included)

2000 mm	FORM-STR-20	Ⓢ 2000(w) x 2380(h) x 400(d) mm
2400 mm	FORM-STR-24	Ⓢ 2350(w) x 2380(h) x 400(d) mm
3000 mm	FORM-STR-30	Ⓢ 2950(w) x 2380(h) x 400(d) mm
4000 mm	FORM-STR-40	Ⓢ 3950(w) x 2380(h) x 400(d) mm
5000 mm	FORM-STR-50	Ⓢ 4950(w) x 2380(h) x 400(d) mm
6000 mm	FORM-STR-60	Ⓢ 5950(w) x 2380(h) x 400(d) mm



Bungee tubes



Numbered system for easy assembly



Gloves included

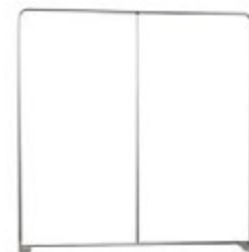

Formulate Horizontal Curve



Formulate Horizontal Curve displays are an eye-catching shape, constructed of lightweight 30mm diameter push-fit aluminium tubing, combined with a zipped tension-fit graphics for tool-free impressive backwalls. Formulate displays offer a variety of great shapes with clean lines, ideal for creating picture backwalls or defining areas in rooms by screening or zoning. The optional double-sided tension fabric graphics perfectly contour the shaped aluminium structures and maximise your brand message.

Material	Aluminium tubes
Tube	Ø 30 mm
Assembly	Push-fit button
Shape	Horizontal curve
Graphic area	Double-sided
Graphic attachment	Zippered tension fabric graphic
Application	Free-standing

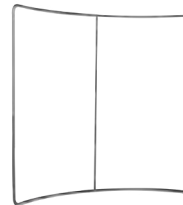

2400 mm	FORM-CUR-24	⊗ 2350(w) x 2380(h) x 500(d) mm			
3000 mm	FORM-CUR-30	⊗ 2950(w) x 2380(h) x 500(d) mm			
6000 mm	FORM-CUR-60	⊗ 5910(w) x 2380(h) x 900(d) mm			
<table border="1"> <tr> <td>Formulate side feet (pair)</td> <td>FORM-SFP</td> <td>⊗ 430(w) x 100(h) x 320(d) mm</td> </tr> </table>			Formulate side feet (pair)	FORM-SFP	⊗ 430(w) x 100(h) x 320(d) mm
Formulate side feet (pair)	FORM-SFP	⊗ 430(w) x 100(h) x 320(d) mm			



Optional side feet
FORM-SFP (Pair)

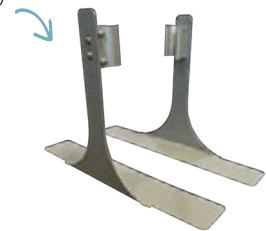

Zippered tension fabric graphic



Bungee tubes



Numbered system for easy assembly



Possibility to add LED Spotlights and Ancillaries

Tension walls

Horizon



Horizon is the ideal solution for large scale promotions. Use single-sided or double-sided to maximise the impact for brand displays. Securely weighted by twin water filled bases for total stability.

Material	Aluminium, moulded grey plastic base
Pole	Adjustable height (1500-2400 mm)
Graphic area	Single or double-sided
Graphic attachment	Eyelets
Base capacity	28 litres per tank
Wind resistance	Up to 12 mph / 19 km/h

Horizon	UB203	⊗ 2500(w) x 1500/3000(h) x 800(d) mm
---------	-------	--------------------------------------



Telescopic pole for adjustable height



Graphic attaches with eyelets

Pegasus



The large-format Pegasus tension banner has telescopic poles and can adjust to 2.5m wide and tall - perfect for large format imagery and brand messaging. Tool-free assembly for quick and simple deployment, Pegasus packs down into a supplied carry bag, and is suitable for vinyl or fabric graphics with pole pockets.

Material	Aluminium
Assembly	Telescopic poles / screws
Shape	Straight
Graphic area	Single or double-sided
Graphic attachment	Pole pocket
Application	Free-standing with feet (included)

Pegasus	UB165-S	1429/2540(w) x 1000/2515(h) x 442(d) mm
---------	---------	---

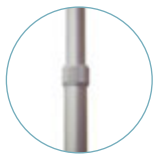

Telescopic poles



Poles slide into graphic pole pocket



Quick and easy installation



Pegasus 3m



The most compact 3m wide video wall! Ideal for large format photo calls for group meetings, political events or product launches.

Material	Aluminium
Assembly	Telescopic twist-lock poles
Shape	Straight
Graphic area	Single sided
Graphic attachment	Pole pocket
Application	Free-standing with feet (included)

Pegasus 3 m	UB167-S	1845/3180(w) x 1835/2610(h) x 440(d) mm
-------------	---------	---

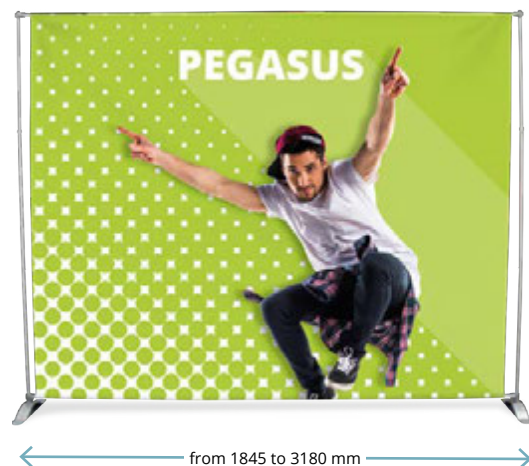

Quick and easy installation



Telescopic poles



Portable Display Banners are ideal for a temporary but stable communication tool.

Our unique range of Display Banners are highly portable, quick to deploy and suitable for a broad range of applications. Choose from the economy range through to premium options for use indoors or select specifically designed solutions for outdoor applications.

Alternatively the fabric systems are a premium display solution, featuring aluminium tubing, with double-sided high-quality dye sublimated fabric graphics. Easy to deploy with tool-free assembly.









Display Banners

Affordable by nature, the roller banner range delivers a convenient, tool-free solution, with retractable graphics that deploy in seconds. Choose from a range of indoor or outdoor designs that best suits your application, with single or double-sided graphic options.

Tension banners are constructed of lightweight materials and offer the best value for money.

Economy Range								
	Model	Width	Heights	Feet / Base	Sides	Outdoor	Key Features	Bag
	Wasp	600, 800, 850, 1000 mm	2000 mm fixed (600 mm model; 1600 or 2000 mm)	Aluminium base; twin twist-out feet	Single	No	Snap top rail; Plastic end caps	Nylon carry bag
	Mantis	800, 850, 1000 mm	2000 mm fixed	Weighted base; twin twist-out feet	Single	No	Snap top rail; Reinforced end caps	Padded carry bag
	Mosquito	800, 850, 1000, 1200, 1500, 2000 mm	2000 mm fixed	Twin twist-out feet	Single	No	Snap top rail; Reinforced end caps; Self-adhesive leader	Padded nylon bag
	Grasshopper	800, 850 mm	2000 mm fixed	Twin twist-out feet; rigidising bracket	Single	No	Adhesive top rail; Self-adhesive leader	Padded carry bag
	Dragonfly 2	850, 1000 mm	2000 mm fixed	Twin twist-out feet	Double	No	Snap rail; Built-in pole storage	Padded nylon bag

Standard Range								
	Model	Width	Heights	Feet / Base	Sides	Outdoor	Key Features	Bag
	Orient+	800, 850, 1000, 1200, 1500, 2000 mm	Adjustable 1500-2000 mm (hybrid telescopic)	Weighted base; adjustable levelling feet	Single	No	Front-loading graphic; Dual-action rail	Premium padded bag
	Delta Lite	850 mm	Adjustable: 1600-2000 mm (hybrid telescopic)	Wide footprint; adjustable levelling feet	Single	No	Snap top rail; Chrome end covers	Padded carry bag
	Thunder 2	850 mm	2000 mm fixed	Twin twist-and-lock feet; 4 ground pegs	Double	Yes, Beaufort 5 pegged	Outdoor rated; Snap rail + self-adhesive leader	Padded carry bag

Premium Range								
	Model	Width	Heights	Feet / Base	Sides	Outdoor	Key Features	Bag
	Merlin	850 mm	Adjustable 1650 - 2300 mm (hybrid telescopic)	Wide footprint; levelling feet	Single	No	Interchangeable cassette; Snap top rail	Padded nylon bag
	Barracuda	800, 850, 1000, 1200, 1500, 2000, 2400 mm	Adjustable 1600 - 2200 mm (hybrid telescopic)	Wide footprint; levelling feet	Single	No	Ratchet tensioner; Front-loading graphic; Large graphic housing	High-quality padded bag

Roller banners (economy)

Wasp



The Wasp roller banner is an entry level product, ideal for short-term events or displays, where cost is a primary consideration. Despite its affordable price, Wasp is made to exacting quality standards and carries a full manufacturer's warranty, so you can be confident it will perform as expected.

Material	Aluminium, plastic end caps on rail and feet tips
Rail	Snap rail
Pole	Aluminium three-part bungee pole
Leader	Self-adhesive
Graphic area	Single-sided
Feet	Twin, twist-out feet
Transport	Simple nylon bag

600 mm	UB204-600-05	⊗ 615(w) x 1710/2080(h) x 320(d) mm
800 mm	UB204-800-03	⊗ 815(w) x 2080(h) x 320(d) mm
850 mm	UB204-850-03	⊗ 865(w) x 2080(h) x 320(d) mm
1000 mm	UB204-1000-03	⊗ 1015(w) x 2080(h) x 320(d) mm

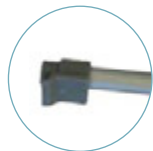

Pole top



Pole bracket



Carry bag



Mantis



The Mantis roller banner is suitable for budget conscious users, who need a cost-effective roller banner with a little more durability for busier areas. With a weighted base, the unit provides enhanced stability over the unweighted banners in the range. Despite its economical price, Mantis is made to exacting quality standards and carries a full manufacturer's warranty, so you can be confident it will perform as expected.

Material	Aluminium, plastic end caps on rail
Rail	Snap
Pole	Bungee
Leader	Self-adhesive
Graphic area	Single-sided
Feet	Twin, twist-out feet
Transport	Padded nylon bag with side opening

800 mm	UB216-800-01	⊗ 818(w) x 2085(h) x 280(d) mm
850 mm	UB216-850-01	⊗ 868(w) x 2085(h) x 280(d) mm
1000 mm	UB216-1000-01	⊗ 1018(w) x 2085(h) x 280(d) mm



Pole top



Rigidising bracket in base for increased strength and longevity of banner



Mosquito



The Mosquito roller banner is an industry standard workhorse. This roller banner offers a blend of affordability, durability and robustness that is often copied, but never equalled. It is constructed from more robust componentry, allowing it to perform reliably in high traffic applications, or where there are likely to be repeated deployments of the roller banner.

Material	Aluminium and plastic
Rail	Snap rail
Pole	Aluminium three-part bungee pole
Leader	Self-adhesive
Graphic area	Single-sided
Feet	Twin, twist-out feet
Transport	Nylon bag with inner protection (double skin)

800 mm	UB197	⊗ 860(w) x 2105(h) x 285(d) mm
850 mm	UB196	⊗ 910(w) x 2105(h) x 285(d) mm
1000 mm	UB197-1000	⊗ 1060(w) x 2105(h) x 285(d) mm
1200 mm	UB197-1200	⊗ 1260(w) x 2105(h) x 285(d) mm
1500 mm	UB197-1500	⊗ 1560(w) x 2105(h) x 285(d) mm
2000 mm	UB197-2000	⊗ 2060(w) x 2105(h) x 285(d) mm



Market favourite



Nylon bag with padded inner protection



Three-part bungee pole



Rigidising bracket in base for increased strength and longevity of banner



Grasshopper



The Grasshopper roller banner is an industry standard workhorse. A popular, classic-style lightweight economy banner with twin twist-out feet for stability. This roller banner offers a blend of affordability, durability and robustness.

Material	Aluminium and plastic
Rail	Adhesive Rail
Pole	Aluminium three-part bungee pole
Leader	Self-adhesive
Graphic area	Single-sided
Feet	Twin, twist-out feet
Transport	Nylon bag with inner protection (double skin)

800 mm	UB191	⊗ 860(w) x 2105(h) x 285(d) mm
850 mm	UB193	⊗ 910(w) x 2105(h) x 285(d) mm

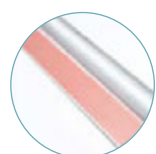

Self-adhesive rail



Three-part bungee pole



Rigidising bracket in base for increased strength and longevity of banner



Dragonfly 2



Economical and cost-effective double-sided roller banner with pole storage in base. Comes with padded nylon bag for ease of transportation.

Material	Aluminium, plastic end caps on rail
Rail	Snap rail with end caps
Pole	Aluminium three-part bungee pole
Leader	Self-adhesive
Graphic area	Double-sided
Feet	Twin, twist-out feet
Transport	Padded nylon bag

850 mm	UB199-850-01	⊗ 890(w) x 2105(h) x 395(d) mm
1000 mm	UB199-1000-01	⊗ 1040(w) x 2105(h) x 395(d) mm



Three-part bungee pole



Nylon padded carry bag included

Double-sided



Roller banners (standard)

Orient +



The Orient + is a trusted market leading roller banner that delivers stability whilst still being cost-effective. With its front-loading graphic that pulls up from the front of the base, the banner design ensures your brand message has maximum visibility from floor to top rail. It comes with our manufacturer's quality warranty, giving peace of mind.

Material	Aluminium and plastic
Rail	Patented Dual action self-adhesive and snap rail
Pole	Hybrid adjustable height telescopic pole
Leader	Self-adhesive or Hook and Loop
Graphic area	Single-sided
Feet	Adjustable
Transport	Padded nylon bag with side opening and foam reinforced ends

800 mm	WH353-800-003	⊗ 840(w) x 1595/2220(h) x 185(d) mm
850 mm	WH353-850-003	⊗ 890(w) x 1595/2220(h) x 185(d) mm
1000 mm	WH353-1000-003	⊗ 1040(w) x 1595/2220(h) x 185(d) mm
1200 mm	WH353-1200-003	⊗ 1240(w) x 1595/2220(h) x 185(d) mm
1500 mm	WH353-1500-003	⊗ 1540(w) x 1595/2220(h) x 185(d) mm
2000 mm	WH353-2000-003	⊗ 2040(w) x 1595/2220(h) x 185(d) mm



Hybrid telescopic pole



Pole top



Banner components

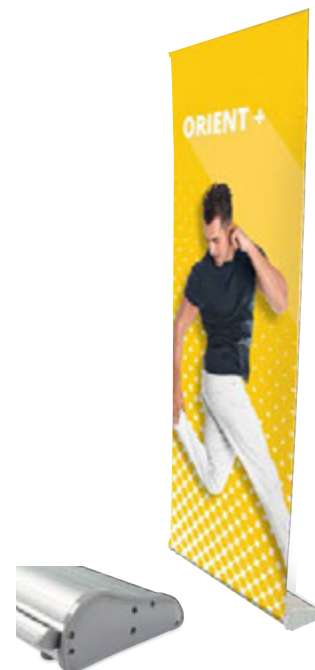

Delta Lite



The Delta Lite roller banner is highly stylish and has great stability thanks to the wide footprint aluminium base. This elegant banner has great design details including the chrome finished end covers. With adjustable levelling feet and telescopic pole, Delta Lite is excellent value for money. It comes with our manufacturer's quality warranty, giving you peace of mind that it will perform every time.

Material	Aluminium, chrome base end covers
Rail	Snap rail with end caps
Pole	Hybrid adjustable height telescopic pole
Leader	Self-adhesive
Graphic area	Single-sided
Feet	Adjustable
Transport	Padded nylon bag

850 mm	UB205-850-004	903(w) x 1625/2224(h) x 203(d) mm
--------	---------------	-----------------------------------



Snap rail



Hybrid telescopic pole



Thunder 2



The Thunder 2 double-sided retractable roller banner is ideal for outdoor use as it is strong and durable yet very easy to assemble and transport. Standing 2m high, Thunder 2 will display your message on both sides for maximum viewing impact.

Material	Plastic, aluminium and steel
Pole	Three part bungee pole
Graphic area	Double-sided
Graphic attachment	Self-adhesive leader / top snap rail
Ground fixing	4 pegs (included)
Wind resistance	Up to 7 mph / 11 km/h (unpegged) up to 24 mph / 39 km/h (if pegged)
Transport	Padded bag

Thunder 2	UB185-850-01	884(w) x 2100(h) x 740(d) mm
-----------	--------------	------------------------------



Three-part bungee pole



Ground pegs

Use outdoors



Roller banners (premium)

Merlin



Merlin is a sleek and elegant premium roller banner with an interchangeable graphic cassette which extends the life of the banner as graphics are quick and easy to change. The graphic cartridge is housed independently from the main base unit so it is simple to remove and replace with new graphics and old graphics can also be reused, just by swapping the cassette. A great value-for-money solution if the message or marketing campaign changes regularly. The Merlin roller banner comes with our manufacturer's quality warranty, giving peace of mind that it will perform every time.

Material	Aluminium and plastic
Rail	Snap rail
Pole	Hybrid adjustable height telescopic pole
Leader	Cassette banner with adhesive leader
Graphic area	Single-sided
Feet	Adjustable
Transport	Padded nylon with side opening and foam reinforced ends

850 mm	UB160-850-01	⊗ 915(w) x 1655/2315(h) x 195(d) mm
--------	--------------	-------------------------------------



Interchangeable graphic cassette - swap messaging in seconds



Replacement cassette - 850 mm UB175-850-01

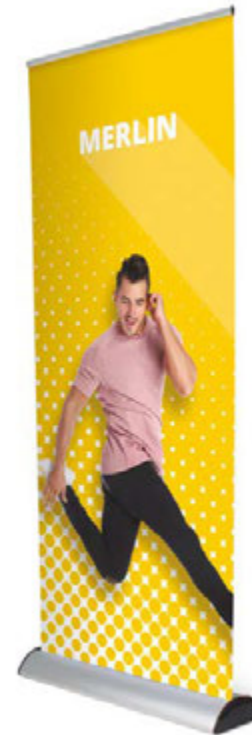

Barracuda



The original best-selling premium Barracuda roller banner delivers a reliable, enduring display which is backed up by a life-time manufacturer's hardware warranty. The stylish Anodised Silver aluminium base has an elegant pinstripe detail on the front casing. Barracuda is height adjustable and has a large internal graphic housing and tensioner.

Material	Aluminium and plastic
Rail	Patented snap rail
Pole	Hybrid adjustable height telescopic pole
Leader	Self-adhesive slider
Graphic area	Single-sided
Feet	Adjustable
Transport	Padded nylon with side opening and foam reinforced ends

800 mm	WH321C-800A3	⊗ 860(w) x 1605/2210(h) x 200(d) mm
850 mm	WH321C-850A3	⊗ 910(w) x 1605/2210(h) x 200(d) mm
1000 mm	WH321C-1000A3	⊗ 1060(w) x 1605/2210(h) x 200(d) mm
1200 mm	WH321C-1200A3	⊗ 1260(w) x 1605/2210(h) x 200(d) mm
1500 mm	WH321C-1500A3	⊗ 1560(w) x 1605/2210(h) x 200(d) mm
2000 mm	WH321C-2000A3	⊗ 2060(w) x 1605/2210(h) x 200(d) mm
2400 mm	WH321C-2400A3	⊗ 2460(w) x 1605/2210(h) x 200(d) mm



New 850mm available

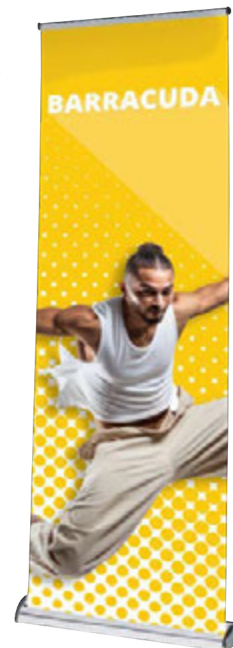

Hybrid telescopic pole



Rail cap

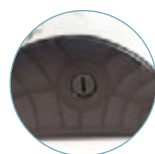

Ratchet graphic tensioner



FASTFRAME™

FASTFRAME™ 1000x500 - 2 Pack



Fastframe™	FF-100X50	1000(w) x 500(h) x 40(d) mm
Fastframe™ (Black back graphic)	G-FF-100X50-BB	1000(w) x 500(h)
Fastframe™ (Polyester stretch graphic)	G-FF-100X50-PS	1000(w) x 500(h)



Portable carry bag



Feet can be added if required. Feet sold separately



Silicone Edged Graphics (SEG)



FASTFRAME™ 1000x1000 - 2 Pack



Fastframe™	FF-100X100	1000(w) x 1000(h) x 40(d) mm
Fastframe™ (Black back graphic)	G-FF-100X100-BB	1000(w) x 1000(h)
Fastframe™ (Polyester stretch graphic)	G-FF-100X100-PS	1000(w) x 1000(h)



Portable carry bag



Feet can be added if required. Feet sold separately



Silicone Edged Graphics (SEG)



FASTFRAME™ 950x2000



Fastframe™	FF-95X200	Ⓢ 954(w) x 2007(h) x 400(d) mm
Fastframe™ (Black back graphic)	G-FF-95X200-BB	Ⓢ 950(w) x 2000(h)
Fastframe™ (Polyester stretch graphic)	G-FF-95X200-PS	Ⓢ 950(w) x 2000(h)



Portable carry bag



Includes 2 x feet



Silicone Edged Graphics (SEG)



FASTFRAME™ 950x2400



Fastframe™	FF-95X240	Ⓢ 954(w) x 2407(h) x 400(d) mm
Fastframe™ (Black back graphic)	G-FF-95X240-BB	Ⓢ 950(w) x 2400(h)
Fastframe™ (Polyester stretch graphic)	G-FF-95X240-PS	Ⓢ 950(w) x 2400(h)



Portable carry bag



Includes 2 x feet



Silicone Edged Graphics (SEG)



FASTFRAME™

FASTFRAME™ 950x2500



Fastframe™	FF-95X250	Ⓞ 954(w) x 2507(h) x 400(d) mm
Fastframe™ (Black back graphic)	G-FF-95X250-BB	Ⓞ 950(w) x 2500(h)
Fastframe™ (Polyester stretch graphic)	G-FF-95X250-PS	Ⓞ 950(w) x 2500(h)



Portable carry bag



Includes 2 x feet



Silicone Edged Graphics (SEG)



FASTFRAME™ 1000x2000



Fastframe™	FF-100X200	Ⓞ 1004(w) x 2007(h) x 400(d) mm
Fastframe™ (Black back graphic)	G-FF-100X200-BB	Ⓞ 1000(w) x 2000(h)
Fastframe™ (Polyester stretch graphic)	G-FF-100X200-PS	Ⓞ 1000(w) x 2000(h)



Portable carry bag



Includes 2 x feet



Silicone Edged Graphics (SEG)



FASTFRAME™ 1000x2400



Fastframe™	FF-100X240	Ⓞ 1004(w) x 2407(h) x 400(d) mm
Fastframe™ (Black back graphic)	G-FF-100X240-BB	Ⓞ 1000(w) x 2400(h)
Fastframe™ (Polyester stretch graphic)	G-FF-100X240-PS	Ⓞ 1000(w) x 2400(h)



Portable carry bag



Includes 2 x feet

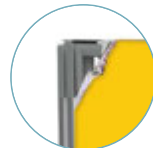

Silicone Edged Graphics (SEG)



FASTFRAME™ 1000x2500



Fastframe™	FF-100X250	Ⓞ 1004(w) x 2507(h) x 400(d) mm
Fastframe™ (Black back graphic)	G-FF-100X250-BB	Ⓞ 1000(w) x 2500(h)
Fastframe™ (Polyester stretch graphic)	G-FF-100X250-PS	Ⓞ 1000(w) x 2500(h)



Portable carry bag



Includes 2 x feet



Silicone Edged Graphics (SEG)



FASTFRAME™

FASTFRAME™ 1200x2400



Fastframe™	FF-120X240	Ⓞ 1204(w) x 2407(h) x 400(d) mm
Fastframe™ (Black back graphic)	G-FF-120X240-BB	Ⓞ 1200(w) x 2400(h)
Fastframe™ (Polyester stretch graphic)	G-FF-120X240-PS	Ⓞ 1200(w) x 2400(h)



Portable carry bag



Includes 2 x feet



Silicone Edged Graphics (SEG)



Tabletop Displays

Breeze



The Breeze mini roller banner is ideal for use on a tabletop, counter, or reception desk. Ultra-light and simple to assemble, it delivers a professional, smart display that is elegant and stylish.

Material	Aluminium, plastic end caps on rail
Rail	Self-adhesive
Pole	Aluminium, two-part pole
Leader	Self-adhesive
Graphic area	Single-sided
Transport	Padded nylon bag

Breeze A4	WH360	Ⓞ 332(w) x 440(h) x 82(d) mm
Breeze A3	WH361	Ⓞ 238(w) x 335(h) x 80(d) mm



Two-piece support pole



Tension banners (X Banner)

Beijing Lite



The Beijing Lite is a basic X-Banner with an ultra-light frame. It is very easy to assemble and compact once packed down.

Material	Fibreglass
Graphic area	Single-sided
Graphic attachment	Eyelets
Application	Free-standing
Transport	Budget drawstring carry bag

600 mm	WH358-6X16-01	ⓐ 600(w) x 1800(h) x 650(d) mm
800 mm	WH358-8X18-01	ⓐ 800(w) x 1800(h) x 650(d) mm



Banner reverse



Graphic attaches with eyelets

Blizzard



Blizzard is a great all-rounder as it is ideal for all kinds of corporate, sporting and outdoor events. Its simple design makes it very easy to assemble on-site, and because it's adjustable, it can accommodate different graphic sizes to suit your application.



Material	Plastic and metal
Pole	Adjustable in width and height
Graphic area	Single-sided
Graphic attachment	Eyelets
Base capacity	12 litres
Wind resistance	Up to 18 mph / 29 km/h
Transport	Non-padded bag

Blizzard	UB701	ⓐ 600/800(w) x 1600/2100(h) x 540(d) mm
----------	-------	---



Non-padded bag included



Tension textile systems

Formulate Monolith



Monolith; the gentle giant, with weighted base for high traffic areas and practical, changeable fabric graphics for multiple brand messaging. This tall double-sided display banner comes in a variety of widths, from 600mm up to 1500mm, and is trusted for stability and easy deployment.

Material	Aluminium tubes, steel base
Tube	Ø 30 mm
Assembly	Push-fit button, Allen key
Graphic area	Double-sided
Graphic attachment	Zipped tension fabric graphic
Application	Free-standing with metal base (included)
Transport	Padded with compartments

600 mm	FORM-MON-600	Ⓞ 600(w) x 2380(h) x 300(d) mm
900 mm	FORM-MON-900	Ⓞ 900(w) x 2380(h) x 300(d) mm
1200 mm	FORM-MON-1200	Ⓞ 1200(w) x 2380(h) x 300(d) mm
1500 mm	FORM-MON-1500	Ⓞ 1500(w) x 2380(h) x 300(d) mm



Hinged metal base (from sizes 900mm wide upward)



Bungee tubes



Formulate Monolith Eco



The Formulate Monolith Eco is an ideal alternative to a roller banner as it provides a cost effective option for the budget conscious whilst delivering an uninterrupted double-sided stretch fabric display. It comes with powder coated steel feet for increased stability that connect to the aluminium tubular frame. The tension graphic hugs the frame and is zipped at the base to hold it in place.

Material	Aluminium tubes, powder coated steel feet
Tube	25mm
Assembly	Push-fit, tool-free
Graphic area	Single or double-sided
Graphic attachment	Tension fabric graphic
Application	Free-standing with feet (included)
Transport	Simple carry bag

800 mm	FORM-MON-ECO-800	Ⓞ 800(w) x 2009(h) x 378(d) mm
1000 mm	FORM-MON-ECO-1000	Ⓞ 1000(w) x 2009(h) x 378(d) mm



Bungee tubes



Numbered system on tubes for easy assembly



Vector Media



Vector Media is a versatile display which accepts a variety of changeable media substrates; from SEG stretch fabric to rollable PVC. Each side of the frame has a channel for SEG fabrics, alternatively you can also use PVC with magnetic tape that magnetise to the inner frame profile.

Material	Aluminium
Profile width	35 mm
Profile Colour	Silver
Assembly	Tool-free
Graphic area	Single or double-sided
Graphic attachment	For textile graphics: 3 mm SEG For PVC graphics: magnetic tape (included)
Application	Free-standing solid foot

Vector Media	VF-MEDIA-16X06	600(w) x 1610(h) x 280(d) mm
--------------	----------------	------------------------------

PVC or fabric graphic, the choice is yours!

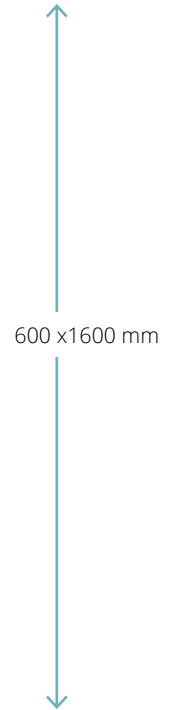

Silicone Edged Graphics (SEG)



PVC graphic with magnetic tape



A comprehensive range of professional display signage solutions for a variety of uses from navigational signs to advertising, information, decorative and display needs.



Display signage solutions are versatile, reusable, durable, and reliable, ensuring investment in hardware is maximised, whilst allowing the flexibility to update marketing messages frequently.

Display Signs

With a wide choice of installation options such as wall, suspended or free-standing, we are proud to offer one of the most comprehensive ranges on the market.



Free-standing signs

Wedge



Wedge is a weighted clamping banner base range that comes in 2 parts and is designed to hold a variety of rigid substrates for indoor or temporary outdoor usage. Available in four sizes from 300mm up to 1000mm, Wedge can be used in tandem with a second pair of bases to create larger displays.

Material	Powder coated steel
Graphic area	Single or double-sided
Graphic attachment	Screwed to base
Graphic option	Rigid panel from 18-40mm thickness - optional extra 1500mm height max.
Application	Free-standing

Wedge 300 mm	UB102-300-S	Ⓞ 300(w) x 85(h) x 360(d) mm
Wedge 600 mm	UB102-600-S	Ⓞ 600(w) x 85(h) x 360(d) mm
Wedge 800 mm	UB102-800-S	Ⓞ 800(w) x 85(h) x 360(d) mm
Wedge 1000 mm	UB102-1000-S	Ⓞ 1000(w) x 85(h) x 360(d) mm



Sentry



Sentry is a handy and versatile way of imparting brand messaging or wayfinding information quickly and tool-free using the 'snap action' poster area which can be deployed either landscape or portrait. A3 and A4 sizes are available and the weighted base aids deployment in high foot-fall areas.

Material	25mm aluminium profile, clear PVC protection sheet
Colour	Anodised Silver, chromed corners
Mounting	Free-standing
Graphic attachment	Snap rail
Graphic option	Suitable for substrates up to 420 microns
Positioning	Portrait or Landscape

Sentry A4	SL104	Ⓞ 245(w) x 1005(h) x 326(d) mm
Sentry A3	SL103	Ⓞ 245(w) x 1075(h) x 326(d) mm



Snap frame

Symbol



Symbol is constructed of robust weighted steel and angled for optimal viewing and reading for better engagement with prospective customers. Interchangeable graphics slide in to the recess channel and fix in place tool-free with a turnscrew.



Material	Steel
Profile colour	Black
Assembly	Allen key and thumb screws
Graphic attachment	Thumbscrews
Graphic option	Rigid PVC and Dibond (3-5 mm thickness)
Weight	7.2 kg
Wind speed	18 mph

Symbol	IP01	420(w) x 1280(h) x 450(d) mm (A4) 480(w) x 1280(h) x 450(d) mm (A3)
--------	------	--



Content detail



Tool-free locking mechanism



Quick change graphic



Whirlwind

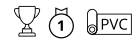

The Whirlwind signage solution is a heavy duty, weather resistant swing sign with a wheeled base for ease of deployment. Base can be filled with a whopping 25 litres of water to keep in place. Double-sided graphics are held securely in a front loading 'snap-action' double-sided panel and it all flat packs for ease of transportation. A perfect piece of kit!



Material	Aluminium, steel, plastic base, PVC sheet cover
Graphic area	Double-sided
Graphic attachment	Snap rail
Graphic option	Banner vinyl
Application	Free-standing

Whirlwind - A1	UB207-A1	780(w) x 1165(h) x 500(d) mm
Whirlwind - A0	UB207-A0	1010(w) x 1554(h) x 625(d) mm



Tool-free snap rail



Wheels for easy transportation



A-sign Board



Pavement signage is a marketing stalwart. No high street would be without one, and the A-sign Board is one of the best. Simple to use with double-sided 'snap-action' front loading frames, complete with protective PVC sheeting to shield graphics which can be changed over and over again to keep up with brand messaging or offers.



Material	Aluminium, steel, PVC sheet cover
Graphic area	Double-sided
Graphic attachment	Snap rail
Wind speed	18 mph
Weight	10.56 kg

A-sign Board A1	VF204-C	Ⓞ 638(w) x 1060(h) x 825(d) mm
-----------------	---------	--------------------------------

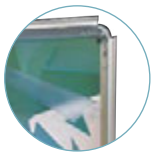

Snap frame



Formulate Shadow



Formulate Shadow is a no fuss outdoor sign offering customers a viable alternative to traditional outdoor signs that typically rely on water or sand for stability.



Material	Steel
Assembly	Push-fit button/Allen key
Tube	32 mm
Graphic area	Double-sided
Graphic attachment	Zippered tension fabric graphic
Wind resistance	Up to 18 mph / 29 km/h
Weight	12.7 kg

Formulate Shadow	FORM-ODS	Ⓞ 800(w) x 1174(h) x 420(d) mm
------------------	----------	--------------------------------



Integrated castors



Base with handle



Monsoon



Monsoon is a perfect all-weather sturdy single or double-sided 'A' frame banner with bungeed PVC eyelet banner graphics - perfect for displaying brand messaging or wayfinding information.

Material	Aluminium tubes (25 mm), plastic connectors
Graphic area	Single or double-sided
Graphic attachment	Eyelets and looped bungee cords
Wind resistance	Up to 24 mph / 39 km/h

Monsoon 2500 mm	UB707-C	Ⓞ 2500(w) x 1000(h) x 640(d) mm
Monsoon 3000 mm	UB711-C	Ⓞ 3000(w) x 1250(h) x 795(d) mm



Eyeletted graphic attaches to frames with bungee cord



Metal hinge

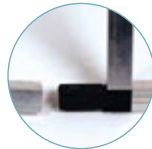

Interlocking sections



Stowaway



Make brand messaging or wayfinding information literally pop with the Stowaway pop-out display banner that deploys in seconds for use either indoors or secured outside with pegs supplied.

Material	Sprung steel pole
Graphic area	Double-sided
Graphic attachment	Elasticated pole pocket
Ground fixing	4 pegs (included)
Transport	Carry bag included
Wind Speed	18 mph (when pegged)

Stowaway 1400 mm	UB736-03A	Ⓞ 1420(w) x 700(h) x 400/480(d) mm
Stowaway 2000 mm	UB736-01A	Ⓞ 2020(w) x 1000(h) x 400/480(d) mm



Internal hook and loop straps



Portable carry bag

Formulate Round Table



The Formulate Round Table is a popular table shape for reception with a welded base for extra stability. Display your message at 360° angle with optional washable tension fabric graphic.

If you already have a display table and are looking for a custom printed tablecloth to promote your messaging, then contact us for a custom made quote. So whether you are looking for a large table cloth with hem, or smaller option with a slim silhouette, we can create a striking made to measure graphic to suit.

Material	Polypropylene
Assembly	Push-fit buttons
Graphic area	360°
Transport	Carry bag included

Formulate Round Table	FORM-TS-01A	Ⓞ 1000(h) x 600(dia) mm
-----------------------	-------------	-------------------------



Padded carry bag included

Simple assembly using numbered system

Ask about our custom printed tablecloths to promote your messaging

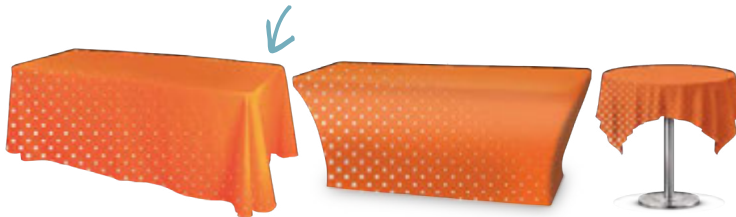

Custom Table Cloth	G-TAB-220x150	Ⓞ 2200(h) x 1500(w) mm
Custom Table Cloth	G-TAB-260x150	Ⓞ 2600(h) x 1500(w) mm
Custom Table Cloth	G-TAB-350x160	Ⓞ 3500(h) x 1600(w) mm

Outdoor Table



The Zoom Outdoor Table is a professional event table designed for outdoor use where reliability, flexibility and a clean presentation are essential. Perfect for trade shows, market stalls, catering setups, festivals and branded activations, it combines a sturdy, professional quality build with a smart, contemporary look that pairs seamlessly with the Zoom Tent range for a coordinated outdoor display. Quick and easy tool free construction, along with its portable design, makes the table effortless to take to events, set up and disassemble.

Fully height adjustable, the Zoom Outdoor Table offers five height settings from 654 mm up to 945 mm, so you can set it at a comfortable working height for food service, product display or casual interaction. Built for dependable performance, it offers impressive load capacity for equipment and merchandise, while optional foot weights and flag clamp accessories allow you to create a stable, fully branded outdoor workstation.

Material	Anodised Aluminum Frame
Tube	40mm Hex Profile
Assembly	Scissor frame, easy push fittings, tool free
Weight carried	1.5m 70-80kg 1.9 up to 120kg
Positioning	Five Adjustable Table Heights: 654 / 750 / 786 / 865 / 945mm
Transport	Black Nylon carry bag with bubble wrapped parts, shoulder straps

Zoom Outdoor Table 1500mm	ZOOM-ODT-15	Ⓞ 1450(w) x 654(h) x 550(d)
Zoom Outdoor Table 1900mm	ZOOM-ODT-19	Ⓞ 1970(w) x 654(h) x 550(d)



Adjustable heights



Quick Release clips



Bracket to attach a Zoom+ flag (optional) ZT-FCB



Weight (optional) ZT-BASE



Wall mounted signs

Trappa Frame



The Trappa 'snap-action' Frame delivers a professional look and is quick to fix to a wall and easy to update. Posters can be changed, simply by opening the frame edges.

Material	25mm aluminium profile, clear PVC protection sheet
Colour	Anodised Silver
Mounting	Wall*
Graphic attachment	Snap rail
Graphic option	Suitable for substrates up to 420 microns
Positioning	Portrait or Landscape

Trappa A4	AT401-C	⊗ 241(w) x 328(h) x 13(d) mm
Trappa A3	AT402-C	⊗ 328(w) x 451(h) x 13(d) mm
Trappa A1	AT404-C	⊗ 625(w) x 872(h) x 13(d) mm



* Wall mounting screws not included



Trappa snap frame

Suspended signs

Twista Lite



Twista Lite delivers a smart, modern poster display system that is quick and simple to deploy via the 'snap-action' rail. Versatile, as well as functional, it can be displayed single-sided on walls or double-sided when suspended from ceilings.

Material	Aluminium (rail), plastic (end caps, hooks)
Colour	Grey
Mounting	Wall / Ceiling
Graphic area	Single or double-sided
Graphic attachment	Snap rail

500 mm Kit	TWLHR-500	⊗ 500(w) x 31(h) x 12(d) mm
600 mm Kit	TWLHR-600	⊗ 600(w) x 31(h) x 12(d) mm
800 mm Kit	TWLHR-800	⊗ 800(w) x 31(h) x 12(d) mm
850 mm Kit	TWLHR-850	⊗ 850(w) x 31(h) x 12(d) mm
1000 mm Kit	TWLHR-1000	⊗ 1000(w) x 31(h) x 12(d) mm
1500 mm Kit	TWLHR-1500	⊗ 1500(w) x 31(h) x 12(d) mm
Twista closed grey hook	TWLHR-CG	
Twista left grey moulding	TWLHR-LG	
Twista right grey moulding	TWLHR-RG	
3100 mm (rail only)	TWLHR-3100	⊗ 3100(w) x 31(h) x 12(d) mm



The snap rail clamps media securely



Top rail with hanging



Snap rail

Display Boards

Baseline Panel and Pole Kits



Panel kits are easy to assemble, reconfigure and re-position. Baseline Panel and Pole kits come in two heights (600mm or 700mm) and two widths (900mm or 1000mm). Stabilising feet are included and kits are manufactured to order.

Material	Luxury foam backed loop nylon
Profile Colour	Grey PVC Extrusion
Finishes	Baseline board with grey PVC frame Baseline Plus board with grey PVC frame
Application	Free-standing with stabilising feet (included)

4 Panel Kit - Baseline	KK104G	⊘ 900(w) X 600(h) mm
4 Panel Kit - Baseline Plus	KKP104-96G	⊘ 900(w) X 600(h) mm
6 Panel Kit - Baseline	KK106G	⊘ 900(w) X 600(h) mm
6 Panel Kit - Baseline Plus	KKP106-96G	⊘ 900(w) X 600(h) mm
8 Panel Kit - Baseline	KK108G	⊘ 900(w) X 600(h) mm
8 Panel Kit - Baseline Plus	KKP108-96G	⊘ 900(w) X 600(h) mm
10 Panel Kit - Baseline	KK110G	⊘ 900(w) X 600(h) mm
10 Panel Kit - Baseline Plus	KKP110-96G	⊘ 900(w) X 600(h) mm

6 Panel - Baseline Plus	KKP106-107G	⊘ 1000(w) x 700(h) mm
8 Panel - Baseline Plus	KKP108-107G	⊘ 1000(w) x 700(h) mm
10 Panel - Baseline Plus	KKP110-107G	⊘ 1000(w) x 700(h) mm

Ancillaries / Optional Extras:

300mm Diameter circular base (singular)	LB913S-C	⊘ 300mmØ
Baseline Header Panel	BH153G	⊘ 250mm x 600mm
Baseline Plus Header Panel	KKPH-600G	⊘ 250mm x 600mm
Baseline Header Panel	BH154G	⊘ 250mm x 700mm
Baseline Plus Header Panel	KKPH-700G	⊘ 250mm x 700mm
Baseline Header Panel	BH155G	⊘ 250mm x 900mm
Baseline Plus Header Panel	KKPH-900G	⊘ 250mm x 900mm
Baseline Header Panel	BH156G	⊘ 250mm x 1000mm
Baseline Plus Header Panel	KKPH-1000G	⊘ 250mm x 1000mm
Header pole (2 required for a singular header)	UP201GM	⊘ 250mm High

Attach your items with hook

Each panel can be assembled horizontally or vertically

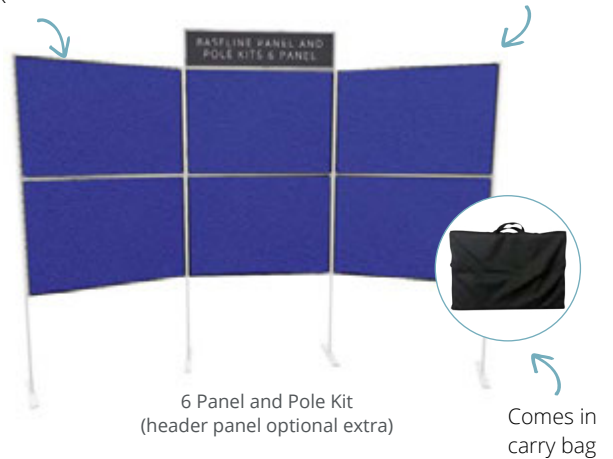

10 Panel Kit (header panel optional extra)

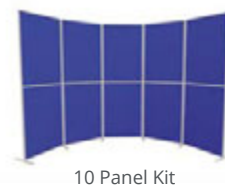
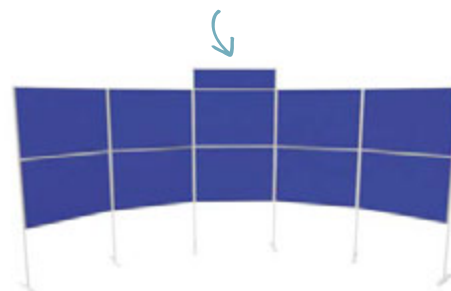

Baseline PVC (thickness 18.2 mm)
Baseline Plus PVC (thickness 25 mm)



25mm

Baseline Tabletop Panel Kits



Baseline Tabletop Panel kits are part of our classic folding panel range of practical and durable displays, ideally sized for counter-tops.

Material	Luxury foam backed loop nylon
Profile Colour	Grey PVC Extrusion
Finishes	Baseline board with grey PVC frame Baseline Plus board with grey PVC frame
Application	Free-standing

Junior kit - Baseline	KK102G	<ul style="list-style-type: none"> ⊖ 1 x 900(w) x 600(h) mm 2 x 450(w) x 600(h) mm Header = 900(w) x 250(h) mm
Senior kit - Baseline	KK103G	<ul style="list-style-type: none"> ⊖ 3 x 600(w) x 900(h) mm Header = 600(w) x 250(h) mm

Attach your items with hook



Baseline PVC
(thickness 18.2 mm)



Comes in carry bag



In a hurry? We've got you covered

Our Junior and Senior Tabletop Panel Kits and 6, 7, 8 Panel Folding Kits are in stock and ready for same-day dispatch when you order before 4pm!

Colour Options

Medici blue on one side and New Grey on the other, offering a professional and versatile finish as standard.

Available Sizes

Choose from Junior or Senior Tabletop Panel Kits and 6, 7, 8 Folding Kits to meet your specific needs.

- Junior: WH512J
- Senior: WH512S
- 6 Fold: WH511
- 7 Fold: WH520
- 8 Fold: WH521

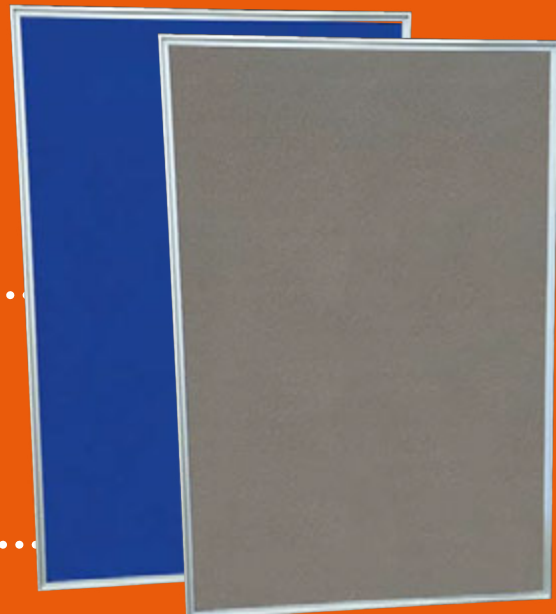

Baseline Panel Folding Kits



Baseline Panel Kits are easy to assemble and versatile. Panels are hinged and available in two heights (900mm and 1000mm) and two widths (600mm and 700mm). Manufactured to order.

Material	Luxury foam backed loop nylon
Profile Colour	Grey PVC Extrusion
Finishes	Baseline board with grey PVC frame Baseline Plus board with grey PVC frame
Application	Free-standing

Attach your items with hook



900 x 600mm Panels:

6 Panel Kit - Baseline	KK117G	Ⓞ 600(w) x 900(h) mm
6 Panel Kit - Baseline Plus	KKP117G	Ⓞ 600(w) x 900(h) mm
7 Panel Kit - Baseline	KK114G	Ⓞ 600(w) x 900(h) mm
7 Panel Kit - Baseline Plus	KKP114G	Ⓞ 600(w) x 900(h) mm
8 Panel Kit - Baseline	KK120G	Ⓞ 600(w) x 900(h) mm
8 Panel Kit - Baseline Plus	KKP120G	Ⓞ 600(w) x 900(h) mm
10 Panel Kit - Baseline	KK124G	Ⓞ 600(w) x 900(h) mm
10 Panel Kit - Baseline Plus	KKP124G	Ⓞ 600(w) x 900(h) mm

1000 x 700mm Panels:

6 Panel - Baseline	KK317G	Ⓞ 700(w) x 1000(h) mm
6 Panel - Baseline Plus	KKP317G	Ⓞ 700(w) x 1000(h) mm
7 Panel - Baseline	KK314G	Ⓞ 700(w) x 1000(h) mm
7 Panel - Baseline Plus	KKP314G	Ⓞ 700(w) x 1000(h) mm
8 Panel - Baseline	KK320G	Ⓞ 700(w) x 1000(h) mm
8 Panel - Baseline Plus	KKP320G	Ⓞ 700(w) x 1000(h) mm
10 Panel - Baseline	KK222G	Ⓞ 700(w) x 1000(h) mm
10 Panel - Baseline Plus	KKP222G	Ⓞ 700(w) x 1000(h) mm

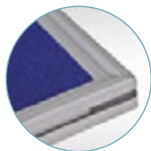

Baseline PVC (thickness 18.2 mm)
Baseline Plus PVC (thickness 25 mm)

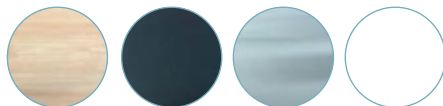

Triangular tabletops available in beech, black, silver and white



Comes in carry bag

Baseline Jumbo Panel Kits



Baseline Jumbo Panel Kits are easy to assemble and re-positionable. Panels are hinged and free-standing. Position panels in multiple ways. Use to create a screen or office partition. Manufactured to order.

Material	Luxury foam backed loop nylon
Profile Colour	Grey PVC Extrusion
Finishes	Baseline board with grey PVC frame Baseline Plus board with grey PVC frame
Application	Free-standing

3 Panel Kit - Baseline	KK350G	⊗ 900(w) X 1800(h) mm*
3 Panel Kit - Baseline Plus	KKP350G	⊗ 900(w) X 1800(h) mm*
4 Panel Kit - Baseline	KK351G	⊗ 900(w) X 1800(h) mm*
4 Panel Kit - Baseline Plus	KKP351G	⊗ 900(w) X 1800(h) mm*

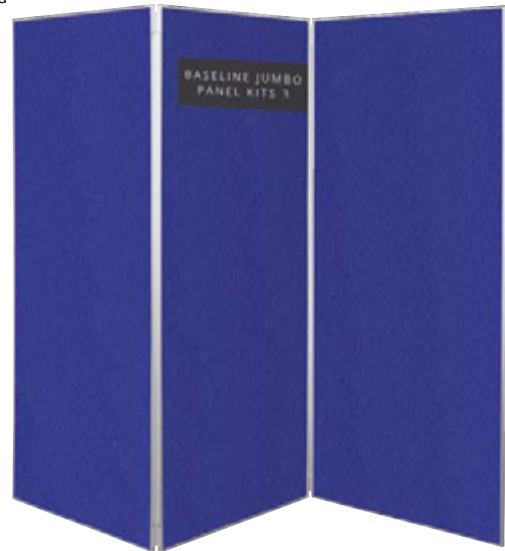

Baseline PVC (thickness 18.2 mm)
Baseline Plus PVC (thickness 25 mm)

*Individual panel size

Baseline Wheeled Panel Kits



Baseline Jumbo Panel Kits are easy to assemble and re-positionable. Panels are hinged and free-standing. Position panels in multiple ways. Use to create a screen or office partition. Manufactured to order.



Baseline Plus Panel Screens come in a choice of 2 different heights with either 5, 6 or 7 panels

5 Panel Baseline Plus Kit - 1500(h) mm	KKPW5-156G	⊗ 600(w) x 1500(h) mm
5 Panel Baseline Plus Kit - 1800(h) mm	KKPW5-186G	⊗ 600(w) x 1800(h) mm
6 Panel Baseline Plus Kit - 1500(h) mm	KKPW6-156G	⊗ 600(w) x 1500(h) mm
6 Panel Baseline Plus Kit - 1800(h) mm	KKPW6-186G	⊗ 600(w) x 1800(h) mm
7 Panel Baseline Plus Kit - 1500(h) mm	KKPW7-156G	⊗ 600(w) x 1500(h) mm
7 Panel Baseline Plus Kit - 1800(h) mm	KKPW7-186G	⊗ 600(w) x 1800(h) mm

*Individual panel size

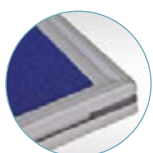

Baseline Plus PVC (thickness 25 mm)

When Folded

Height	Width	Depth
1550mm	600mm	125mm
1550mm	600mm	150mm
1550mm	600mm	175mm
1850mm	600mm	125mm
1850mm	600mm	150mm
1850mm	600mm	175mm

Extended Panel

Length	Diagram
1800mm	
2400mm	
3000mm	
1800mm	
2400mm	
3000mm	

Extended Panel

Length	Diagram
2750mm	
3300mm	
3850mm	
2750mm	
3300mm	
3850mm	

Approximate dimensions depending on the set up

ADDITIONS: Baseline Panels – Customisable and Versatile Display Solutions

Baseline panels are perfect for expanding your existing display boards or building a completely custom setup. These configurable panels offer flexibility to create displays tailored to your unique needs, whether for exhibitions, events, or office spaces.

Fully Customisable: Add extra panels to your current setup or combine them to design a display board from scratch.

Flexible Configuration: Adapt the layout to suit your space and messaging requirements with ease.

Accessories Sold Separately: Please note that all clips and poles are sold separately, giving you the freedom to choose only the components you need.

Baseline vs. Baseline Plus

The key difference between Baseline and Baseline Plus panels lies in their thickness:

Baseline Panels: Standard thickness, ideal for lightweight and portable setups.

Baseline Plus Panels: A thicker, more robust option for increased durability and stability.

Whether you're enhancing an existing display or starting fresh, Baseline panels offer the quality and flexibility you need to create impactful presentations.

BP101G	Baseline Panel 600mm x 450mm
BP102G	Baseline Panel 900mm x 600mm
BP105G	Baseline Panel 1000mm x 700mm
BP107G	Baseline Panel 1000mm x 1000mm
BP110G	Baseline Panel 1500mm x 1000mm
BP112G	Baseline Panel 1800mm x 900mm
BP113G	Baseline Panel 2000mm x 1000mm
KKP-96G	Baseline Plus Panel 900mm x 600mm
KKP-107G	Baseline Plus Panel 1000mm x 700mm
KKP-101G	Baseline Plus Panel 1000mm x 1000mm
KKP-189G	Baseline Plus Panel 1800mm x 900mm



Baseline PVC (thickness 18.2 mm)
Baseline Plus PVC (thickness 25 mm)

Ancillaries

25mm Poles

The display panel male and female poles are essential components designed for secure and versatile assembly of modular display systems.

Male Pole: Features a precise connector that fits seamlessly into the female pole, ensuring a stable and reliable connection. Ideal for creating vertical structures or supporting panels with ease.

Female Pole: Crafted to receive the male pole connector, providing a snug and sturdy fit.

The poles are designed for compatibility and quick assembly during exhibitions or events.

Both poles are made from durable, lightweight materials, ensuring they are easy to transport while being structurally sound. Their sleek design blends effortlessly with various display systems, making them a practical and professional choice for any setup. All poles are finished in grey and are sold separately.

UP201GF	25mm x 250mm Female Pole
UP201GM	25mm x 250mm Male Pole
UP204GF	25mm x 600mm Female Pole
UP204GM	25mm x 600mm Male Pole
UP205GF	25mm x 900mm Female Pole
UP205GM	25mm x 900mm Male Pole
UP206GF	25mm x 1000mm Female Pole
UP206GM	25mm x 1000mm Male Pole
UP209GM	25mm x 1800mm Male Pole
UP209GF	25mm x 1800mm Female Pole
UP210GF	25mm x 2000mm Female Pole
UP210GM	25mm x 2000mm Male Pole



Ancillaries

Bases

AG712S	Channel Feet
LB913S-C	300mm Diameter Circular Base (Singular)

Supplied with M8 Hex bolt for attaching to 25mm diameter poles

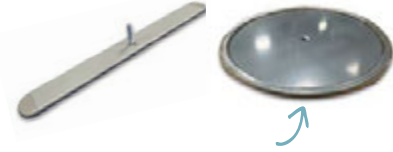

Optional carry bag available for this product

Clips

ULMO02-G	25mm Pole Clip Grey (Single)
GA106G	25mm Pole Clip Grey (Pack of 10)
ULMO04-G	0mm Panel Clip Grey (Single)
GA103G	0mm Panel Clip Grey (Pack of 10)



Supplied in packs of 10

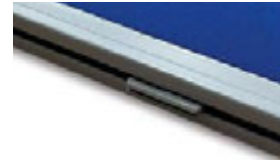

Hook

AG707	25m roll
-------	----------



Panel Bags

Baseline Panel & Pole Kits (900 x 600mm size)

4 Panel	KK104G	AB110
6 Panel	KK106G	AB110
8 Panel	KK108G	AB109A
10 Panel	KK110G	AB110A

Baseline Plus Panel & Pole Kits (900 x 600mm size)

4 Panel	KKP104-96G	AB110
6 Panel	KKP106-96G	AB114A
8 Panel	KKP108-96G	AB114A
10 Panel	KKP110-96G	AB114A

Baseline Panel & Pole Kits (1000 x 700mm size)

6 Panel	KKP106-107G	AB114A
8 Panel	KKP108-107G	AB114A
8 Panel	KKP110-107G	AB114A

Baseline Folding Kits (900 x 600mm size)

Junior	KK102G	AB110
Senior	KK103G	AB110
6 Panel	KK117G	AB110
7 Panel	KK114G	AB110A
8 Panel	KK120G	AB110A
10 Panel	KK124G	AB110A

Baseline Folding Kits (1000 x 700mm size)

6 Panel	KK317G	AB114A
7 Panel	KK314G	AB114A
8 Panel	KK320G	AB114A
10 Panel	KK222G	AB114A

Baseline Plus Folding Kits (900 x 600mm size)

6 Panel	KKP117G	AB110A
7 Panel	KKP114G	AB110A
8 Panel	KKP120G	AB110A
10 Panel	KKP124G	2 x AB110A

Baseline Plus Folding Kits (1000 x 700mm size)

6 Panel	KKP217G	AB114A
7 Panel	KKP314G	AB114A
8 Panel	KKP320G	2 x AB114A
10 Panel	KKP222G	2 x AB114A



Base Bag

AB108

Base Bag (4 bases fit in one bag)
Suitable for LB913S-C bases only

**Our new Digital Display
Range, expanding our
portfolio of Creative
Display Solutions.**

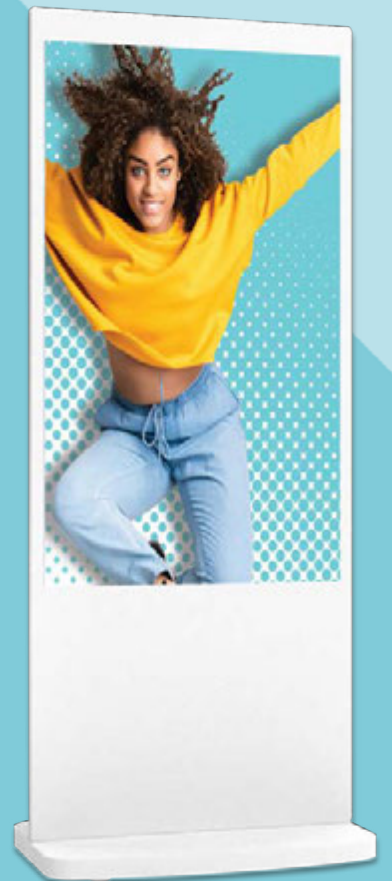

Created in response to rising customer demand, the range includes menu screens, advertising totems, and ultra-wide displays – all designed to boost brand visibility and audience engagement.

Each display is easy to use and backed by a 3-Year Warranty and Lifetime Technical Support. Content can be updated via USB or via an optional remote CMS license, which also supports interactive touchscreen content.

The Digital Display Range expands our creative display solutions offering – providing more ways to captivate, connect, and convert.

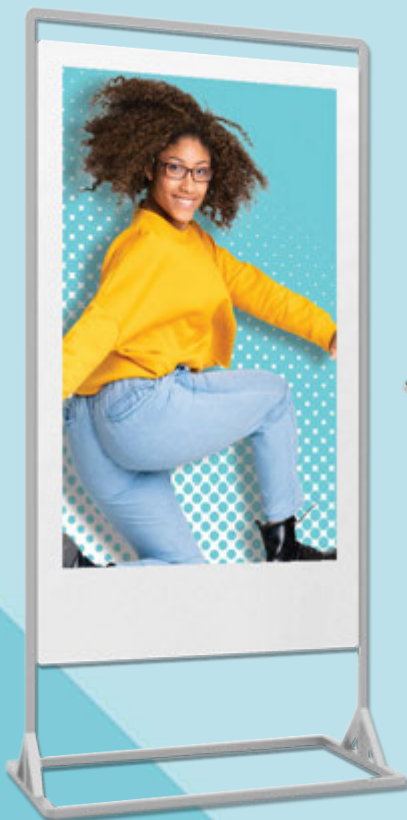

Digital screens

Android Freestanding Digital Poster



Show-stopping digital advertising totems with giant tablet styling
Available in 50", 55" and a 4K 65"

- Premium brushed aluminium finish
- Retractable castors for effortless mobility
- Tempered glass front for strength and safety

SCREEN SIZE	PRODUCT CODE (WHITE)	PRODUCT CODE (BLACK)	SIZE (MM)	WEIGHT (KG)
50"	L50HD9W	L50HD9	1950 x 900 x 600	78
55"	L55HD9W	L55HD9	2020 x 900 x 600	93
65"		L65UHD3	2170 x 990 x 790	102



Giant Tablet Styling



Internal Locker



Recessed Rear Handles



Black Version Available

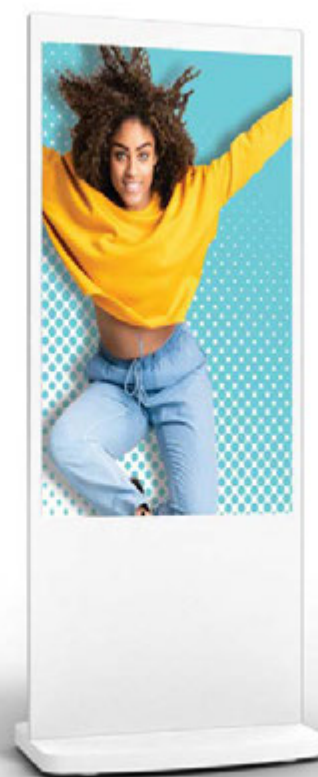

Slimline Pro Advertising Displays



Premium displays that combine stunning tablet-like aesthetics with a robust protective enclosure and tempered glass face. Available in 22", 32", 43", 50"

- Tempered glass front for strength and safety
- Premium brushed aluminium finish
- Wall mount included

SCREEN SIZE	PRODUCT CODE (WHITE)	SIZE (MM)	WEIGHT (KG)
22"	PF22HD9	680 x 430 x 130	8.1
32"	PF32HD9	870 x 563 x 165	13.85
43"	PF43HD9	1095 x 688 x 170	20.35
50"	PF50HD9	1279.2 x 818 x 199	37



Unique Concave Indent Profile



Free Flush-Fit Wall Mount



Integrated Android Media Player



Connect External Devices



Superslim Freestanding Double-Sided Digital Posters



Dual-sided advertising displays with incredibly slim depth and striking brushed aluminium frame. Available in 43" & 55"

- Premium brushed aluminium finish
- Double-sided display
- Exceptional screen brightness - 700 cd/m²

SCREEN SIZE	PRODUCT CODE	SIZE (MM)	WEIGHT (KG)
43"	LHDSB43HD8	1840 x 684.6 x 25	29
55"	LHDSB55HD8	1940 x 867.2 x 25	39

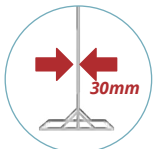

Superslim Profile



Premium Brushed Aluminium Finish



Double-Sided Display



Ultra-Resistant to Blackening Defect



Android PCAP Touch Screen Kiosks



Fully integrated kiosk solution featuring rear ports and connections for use with built-in or third party PC
Available in 43", 50" & 55"

- Powered by Android
- 24/7 Commercial Use
- Internal Lockers

SCREEN SIZE	PRODUCT CODE	SIZE (MM)	WEIGHT (KG)
43"	TAO43H	SCREEN: 1095 x 690 x 170 STAND: 1000 x 690 x 430	73.5
50"	TAO50H	SCREEN: 1270 x 875 x 200 STAND: 1000 x 690 x 430	86
55"	TAO55H	SCREEN: 1405 x 870 x 195 STAND: 1000 x 690 x 430	89

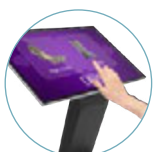

10 Touch Points



Surface Plasma Treatment

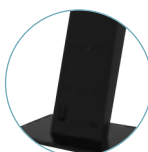

Internal Locker

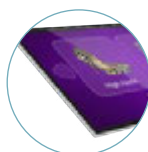

Giant Tablet Styling



POWERED BY ANDROID™

Windows PCAP Touch Screen Kiosks



Fully integrated kiosk solution featuring rear ports and connections for use with built-in or third party
Available in 43", 50" & 55"

- Integrated Windows PC
- 24/7 Commercial Use
- Internal Lockers

SCREEN SIZE	PRODUCT CODE	SIZE (MM)	WEIGHT (KG)
43"	TWP43B	SCREEN: 1095 x 690 x 170 STAND: 1000 x 690 x 430	73.5
50"	TWP50B	SCREEN: 1270 x 875 x 200 STAND: 1000 x 690 x 430	86
55"	TWP55B	SCREEN: 1405 x 870 x 195 STAND: 1000 x 690 x 430	89

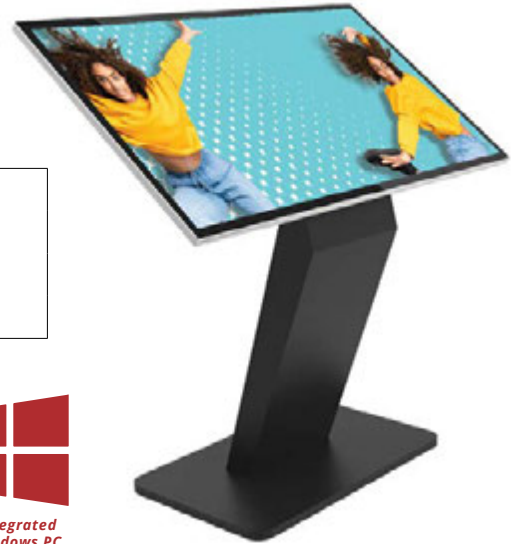

10 Touch Points



Surface Plasma Treatment



Internal Locker



Giant Tablet Styling



Ultra-Wide Stretched Bar Displays



Perfect as a banner-style endcap display in retail stores and supermarkets. Available in 28", 37" and a 76" Stretched Bar Monitor

- USB Plug and Play option
- Mounting Bracket included
- Exceptional screen brightness

SCREEN SIZE	PRODUCT CODE	SIZE (MM)	WEIGHT (KG)
28"	WS28HD8-B	880 x 295 x 130	7.05
37"	WS37HD8	872 x 315 x 130	7
76"	WS76M2	1055 x 390 x 140	8.6



Synchronise Multiple Displays



Narrow Bezel



Multiple Media Zones



Connect Devices

Network Digital Boards



Fully integrated kiosk solution featuring rear ports and connections for use with built-in or third party. Available in 32", 43", 50" & 55"

- Mounting bracket included
- Exceptional screen brightness - 450 cd/m²

SCREEN SIZE	PRODUCT CODE	SIZE (MM)	WEIGHT (KG)
32"	DM32D	870 x 565 x 170	11.8
43"	DM43D	1067 x 660 x 163	15.2
50"	DM50D	1238 x 760 x 195	28.9
55"	DM55D	1380 x 835 x 195	23.95



Narrow Bezel



Landscape or Portrait Orientation



Integrated Network Android Media Player

High Brightness Outdoor Digital Battery A-Boards



Sunlight readable and fully portable solution for any space; display content all day and night from a single charge. Available in 43"

- Portable with integrated wheels
- 27 hour running time
- Tempered anti-glare glass

SCREEN SIZE	PRODUCT CODE (WHITE)	SIZE (MM)	WEIGHT (KG)
43"	HOAB43HD8	1430 x 753 x 643	62



Battery Powered



Precision-Engineered



Weatherproof IP65-Rated Enclosure



Charge Level Indicator

Draw attention to branding, products, services, or business premises with custom printed flags.

Instantly noticeable due to their height, shape, and movement, our all-fibre flag poles are durable and flexible, easy to assemble and quick to deploy, making them an extremely effective means of advertising.

Choose from a range of free-standing, post / wall mounted, mobile and specialist hardware that can be used in a variety of applications such as car forecourts, festivals, and beach flags.

Alternatively, deploy taller or multiple flags to increase visibility and attention to branding. Our all-fibre flag poles are reusable with interchangeable graphics for greater return on investment. To protect this investment, it is recommended that flags be kept securely in place by selecting an appropriate base suitable for the desired application and location from the specifically designed range.



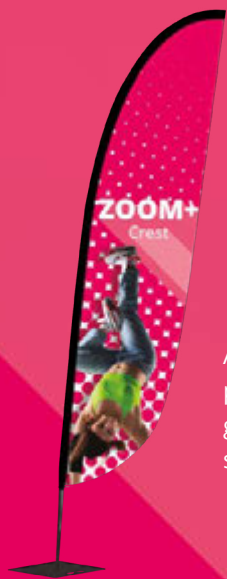

Flags

Available as single or double-sided options and printed using hardy, UV resistant media, flag graphics can be utilised indoors or outside with standard or custom flag shapes.



Free-standing flags

Zoom+ Quill / Feather / Crest Flag



Zoom+ flags are a popular and versatile, lightweight flexible flag system, with black finish all fibre poles. Choose Feather, Quill or Crest shaped graphics. Ideal for advertising and used for all types of indoor and outdoor displays. Optional custom printed flag graphics are available in a range of sizes from small to extra-large and with a choice of single or double-sided options (small, medium, and large). The eye-catching shape creates movement in the wind and is a great for attracting attention.



Material	GRP fibre glass pole
Graphic area	Single-sided or double-sided (double-sided only available up to large)
Graphic attachment	Pole pocket (in choice of black, white or printed)
Wind resistance	Up to 63 mph / 101 km/h*

Zoom + Extra Small	UF-ZM-XS	⊗ 580/535/480(w) x 1880/2150/2120(h) mm
Zoom + Small	UF-ZM-SM	⊗ 550/800(w) x 2100/2600(h) mm
Zoom + Medium	UF-ZM-ME	⊗ 600/900(w) x 2800/3200(h) mm
Zoom + Large	UF-ZM-LA	⊗ 800/1100(w) x 3500/4000(h) mm
Zoom + Extra large	UF-ZM-EXLA	⊗ 850/1200(w) x 4600/4900(h) mm

* Under controlled test conditions



Ancillaries :

Bag (optional)	AB-ZML-01
----------------	-----------



Graphic attaches on to hook

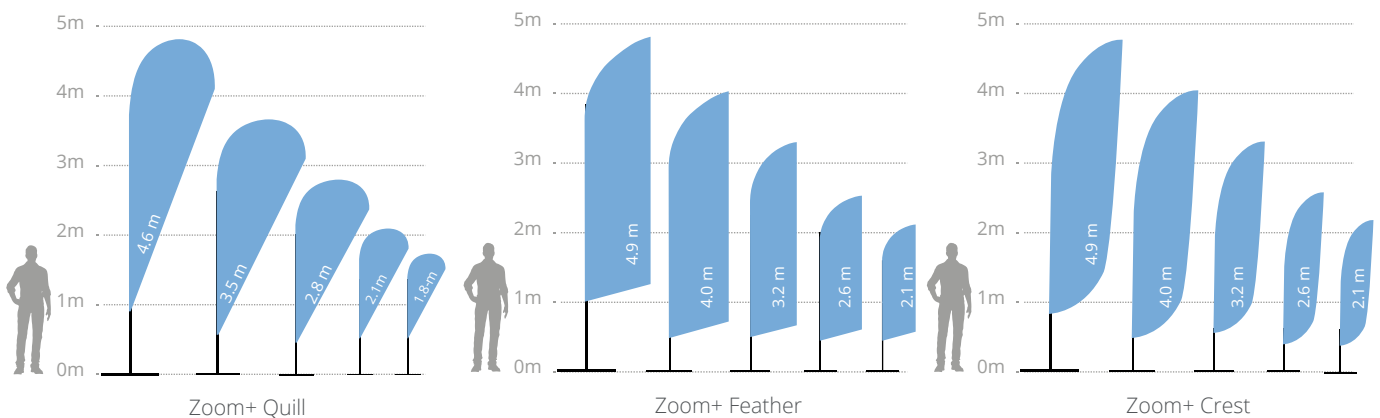

Zoom+ Edge Flag



Zoom+ is a popular and versatile, lightweight rectangular shaped flag system with black finish all-fibre poles. Ideal for all types of indoor and outdoor displays. Quick and easy to deploy and can withstand winds of approximately 13 -18m/h (21-29km/h). Optional custom printed flag graphic available in single and double-sided options (small, medium, and large), and all flag graphics have a printed pole pocket. The flag moves naturally in breezy/windy conditions and is ideal for attracting attention on car forecourts, at exhibitions and events, or outside a building or premises.



Material	Aluminium and GRP
Graphic area	Single-sided or double-sided (double-sided only available up to large)
Graphic attachment	Pole pocket
Wind resistance	Up to 18 mph / 29 km/h

Zoom + Edge Small	UF-ZME-SM	Ⓞ 750(w) x 2080(h) mm
Zoom + Edge Medium	UF-ZME-ME	Ⓞ 750(w) x 2900(h) mm
Zoom + Edge Large	UF-ZME-LA	Ⓞ 750(w) x 4000(h) mm
Zoom + Edge Extra large	UF-ZME-EXLA	Ⓞ 750(w) x 5000(h) mm



Graphic attaches on to hook

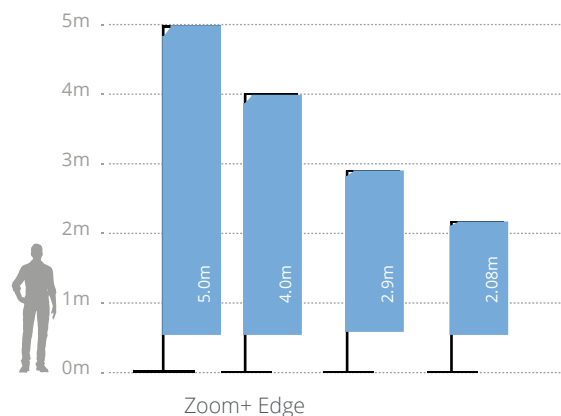

Zoom+ Arch



The Zoom+ Arch stands out at any outdoor event or activity. With an overall height of 3m to the top of the graphic and a 4m width, it's perfect to use as a focal point or to attract attention. Simple and quick to assemble, it can be deployed in minutes and when used with the optional stackable bases, provides an extremely stable display that can be used in wind speeds of up to 20mph.

Material	GRP fibre glass pole - chrome steel end caps, plastic hook
Graphic area	Single-sided
Graphic attachment	Pole pocket
Wind resistance	Up to 19 km/h

Zoom+ Arch	ZOOM+ARCH	Ⓞ 4000(w) x 2500/3000(h) mm
Stackable base (optional) recommended that 2 bases either side are used	UF-ZMSWB	Ⓞ 642(w) x 277(h) x 642(d) mm



Supplied with 1 x 6-part bungee pole, 2 x base rods and hooks



Graphic attaches on to plastic hook



Water fillable base



Handle for easy transportation



Wind Dancer



An imposing telescopic flag which stands 5m high when fully assembled and is certain to make an impact at any outdoor event, Wind Dancer comes complete with a base which can be filled with either water or sand. The 3.5m flag height makes an impressive statement when the flagpole is deployed at its full 5m height, and is particularly impactful when used in large crowded areas because of its dominating presence.

Material	Aluminium pole, plastic base
Pole	Telescopic
Graphic area	Single-sided
Graphic attachment	Eyelets
Base capacity	66 litres
Wind resistance	Up to 18 mph / 29 km/h

Wind Dancer	WD105	Ⓞ 1000(w) x 2900/5300(h) x 1000(d) mm
-------------	-------	---------------------------------------



Largest flag in our range

Post / wall mounted flags

Mistral

1 TEX PVC

The Mistral is a fixed outdoor flag system designed for mounting to lampposts or building exteriors and is perfect for advertising or promoting a brand or event. The mechanism attaches directly to a pole, posts, or wall and can be moved to accommodate varying graphic heights. An eye-catching solution that can also be used for information and wayfinding, this flag is especially effective when repeated over a series of posts.



Material	Aluminium castings and GRP tubes
Tube	Height adjustable
Graphic area	Single-sided or double-sided
Graphic attachment	Pole pocket
Wind resistance	Up to 40 km/h

Mistral	UB725-01	895(w) x 2010(h) mm
---------	----------	---------------------

Can be fixed to a pole or wall



Post fixing

Clamp
(Ø 300mm max)

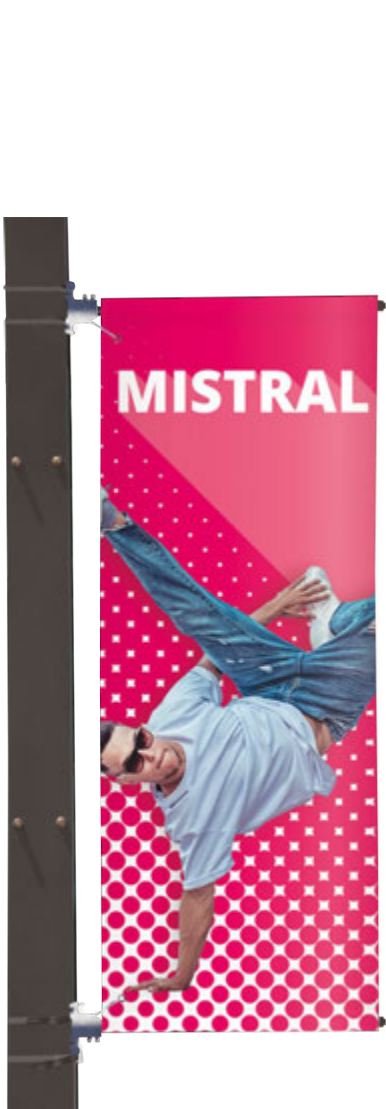

Mobile flags

Street Flag



Street flag is the ideal advertising medium when on the move or when you want to attract attention in a crowded space! Perfectly suited to promote events, highlight presence at trade shows or to organise a group of people on excursions! Rugged and lightweight, the backpack can be used with four different flag shapes and comes complete with fibre poles.

Material	Reinforced nylon backpack, fibre poles
Graphic area	Single-sided
Graphic attachment	Pole pocket
Graphic shapes	Feather - Quill - Edge - X-banner

Street Flag	UF-ZMSTF-01	📏 310(w) x 540(h) x 80(d) mm
-------------	-------------	------------------------------

X-banner



One backpack can be used with 4 flag shapes!

Feather



Quill



Edge



Zippered compartment to store graphics



Reinforced shoulder straps, adjustable strap and side mesh pocket



Storage for poles and rods

Take advantage of outdoor events with a temporary structure and create additional marketing opportunities.

Offer customers protection and shelter from the weather by choosing custom-printed tents that also provide an attractive brand marketing solution.

Conventional pop-up tents and gazebos are fantastic outdoor or indoor structures which provide a unique way to advertise in a vibrant impactful manner with fully printed canopies and walls.

Constructed from robust steel or aluminium in a variety of sizes that are easy to transport, assemble, deploy and pack away, pop-up tents are ideal for short term events, fairs and exhibitions.





Tents

For a more unique and unconventional structure, choose the Bora Inflatable Tent. Simple to inflate for rapid deployment with an appealing eye-catching shape, the Bora, like pop-up tents, also offers optional printed canopies and walls. Customisable areas make highly effective brand

messaging, ensuring maximum impact at events. As with all custom-printed graphics, they can easily be replaced so that hardware is used multiple times, improving return on investment.

Pop-up tents

Zoom Tent Eco



The Zoom Tent Eco is the most cost-effective gazebo in our range. Quick and easy to deploy, the 3x3m tent can easily accommodate a 2.4m wide table making it a great solution for street markets, golf days or sporting events. Made from steel with a white powder coated finish, the frame easily shelters up to five people and folds completely into a portable wheeled carry bag. Custom fully printed canopy and walling is an optional extra.



Material	Steel frame, plastic joins
Graphic area	Double-sided (wall) / single-sided (canopy)
Graphic attachment	Hook and loop
Ground fixing	Pegs and ropes (included)
Wind resistance	Up to 18 mph / 29 km/h
Transport	Wheeled standard bag



Zoom Tent Eco 3x3	FD33-SQF	Ⓜ 3310(w) x 3315/3510(h) x 3310(d) mm
Canopy	FD33-CTW	Colour : White
Wall	FD33-FWW	Colour : White
Zoom Tent/Zoom Tent Eco Flag Clamp Bracket	ZT-FCB	



Use bracket to attach a Zoom+ flag (UF-ZM-XS UF-ZM-SM)



Locking post



Winder for opening and closing



Bracket to attach a Zoom+ flag (optional) ZT-FCB

Zoom Tent



Ensure your event's a success come rain or shine by using an easy to deploy vibrant lightweight aluminium pop-up tent frame system. The Zoom Tent folds out and returns in minutes with tool-free deployment. Dress with a custom full printed canopy, full and half walls. Available in a range of sizes.



Material	Aluminium frame, plastic joins
Graphic area	Double-sided (wall, half wall) / single-sided (canopy)
Graphic colours	White - Black (standard) / Full Graphic (optional)
Graphic attachment	Hook and loop / Pocket (half wall)
Ground fixing	Pegs and ropes (included)
Wind resistance	Up to 18 mph / 29 km/h
Transport	Wheeled Standard Bag

3x3 frame	ZT33-XAF-01	⊗ 2920(w) x 3160(h) x 2920(d) mm
3x4.5 frame	ZT345-XAF-01	⊗ 4300(w) x 3160(h) x 2920(d) mm
3x6 frame	ZT36-XAF-01	⊗ 5800(w) x 3160(h) x 2920(d) mm

Canopy	ZTXX-CTW	Colours : White
Canopy	ZTXX-CTK	Colours : Black
Wall	ZTXX-FWW	Colours : White
Wall	ZTXX-FWK	Colours : Black
Half wall	ZTXX-HWW	Colours : White
Half wall	ZTXX-HWK	Colours : Black

Ancillaries :

7.5 kg Weight	ZT-BASE
Half wall bar 3x3	ZT33-MTB
Half wall bar 3x4.5	ZT345-MTB
Zoom Tent/Zoom Tent Eco Flag Clamp Bracket	ZT-FCB



Pop-up frame



Tent weight (optional)
ZT-BASE



Automatic locking



Crank to tighten
the canopy



Bracket to attach a Zoom+ flag
(optional)
ZT-FCB

Zoom Tent 3x3 Sky Banner



Stand out from the crowd with the Sky Banner and its large print area! This horizontal banner attaches easily to the Zoom Tent 3x3 poles using clamp brackets (2 units to be ordered separately). 2 ZT-BASE ballast weights per pole recommended. Compatible with the Zoom Tent 3x3.

Material	GRP
Graphic area	Single-sided
Graphic colours	Full Graphic (optional)
Graphic attachment	Pocket + hook and loop
Wind resistance	Up to 18 mph / 29 km/h
Transport	Bag included

Zoom Tent 3x3 Sky Banner	ZT33-H-SKY	⊗ 2995(w) x 1515(h) mm
Zoom Tent/Zoom Tent Eco Clamp Bracket	ZT-FCB	





BORA
Tent

Inflatable tents

Bora Tent



The Bora Inflatable Tent is a sturdy and attractive option for outdoor displays. Create shade and shelter for a registration desk, refreshment area or meeting point that fully shows off a brand. As one of the largest products in the range, there is plenty of print area on the canopy and backwalls (optional extra) for brand messaging. The backwalls zip in, so can be changed for a different message from the canopy if you wish. The Bora Tent uses trapped air technology: silent and free-standing once inflated.

Material	TPU, Polyester inner coat
Graphic area	Single-sided
Graphic attachment	Zip system (standard) / hook and loop (full graphic)
Ground fixing	Pegs (optional)
Wind resistance	Up to 24 mph / 39 km/h (if pegged)
Transport	Standard Bag (included)



Bora Tent	INFT3-2Z	3200(w) x 2450(h) x 3200(d) mm
-----------	----------	--------------------------------



400W electric pump (optional) INFTA-PE4EU



Inflation valve



Carry bag included



Parasol

Zoom Parasol



The Zoom Parasol is a professional-grade 2x2 metre square umbrella designed for maximum shade, visibility, and branding impact at outdoor venues. Crafted from a robust 40mm hexagonal aluminium frame, it offers the perfect balance of strength, stability, and modern design. Its durable build ensures it can withstand regular outdoor use, with wind resistance up to 15mph, making it ideal for cafés, markets, festivals, and promotional events.

An optional weather-resistant printed graphic provides a premium branding opportunity, delivering vibrant, high-quality visuals that stand out in any setting.

The parasol base is sold separately.

Material	Aluminium
Profile width	40mm Hex
Assembly	Tool-Free
Graphic area	Single-sided canopy
Graphic attachment	Pocket
Wind resistance	Up to 15mph

Zoom Parasol 2x2	PARA-2X-SQ	2000(w) x 1980(h) x 2000(d) mm
Base	PARA-BASE	520(Ø) x 425(h)



Parasol frame



Locking Bracket



Extrusion Bracket



Base (not included - to be purchased separately)

Temporary counters add a professional touch to any exhibition, event or retail environment.

They provide a useful area for display or presentation space, and the ability to add a graphic creates additional marketing opportunities as well as offering a convenient storage facility.

Our counters are available in a range of price points and shapes, depending on requirements.

Add impact to a welcome desk or a reception area in a public space with an illuminated counter or choose an outdoor option to promote a product or service at an open-air event.



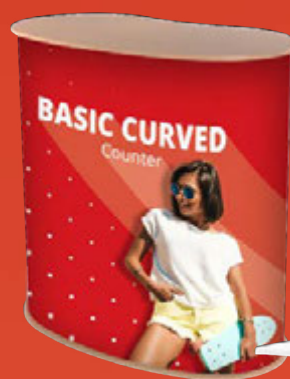

Counters

Counters are the perfect partner for a promotional display or event to complement a backdrop or add focus to an area and are the ideal companions for any marketing campaign.

Promotional counters

Pop-up Counta



The Pop-up Counta is convenient lightweight pop-up counter that offers a substantial area to welcome guests yet packs down for easy transportation in a reinforced D-shaped wheeled trolley case.

The counter comes with shelves for storage and a beech-coloured counter-top. Often used for exhibitions, in supermarkets as a demonstration unit and for events.

Material	Aluminium, plastic and MDF tabletop
Assembly	Self-locking magnetic
Collapsible	Yes
Counter top	Foldable - Beech colour
Shelves	4
Load bearing	25 kg
Shelf bearing	3 kg
Graphic attachment	Magnetic hangers, bars and tape (included). Suitable for 440 microns min. substrate (optional extra)
Transport	1 Wheeled trolley case

Pop-up 2x2	PUC22C-C	📏 1260(w) x 965(h) x 430(d) mm
------------	----------	--------------------------------



Structure



Magnetic fixing



Wheeled carry bag



Hop-up Counta



Hop-up Counta is a durable lightweight hop-up counter, quick and easy to assemble with a single wrap around fabric graphic which stays on when collapsed and packed away. The unit is fitted with a beech effect counter top and provides a perfect welcome for guests.

Material	Aluminium, plastic, MDF tabletop and polycarbonate shelf
Assembly	Plastic locking arms
Collapsible	Yes
Counter top	Beech
Shelves	1
Load bearing	15 kg
Shelf bearing	3 kg
Graphic attachment	Hook and loop
Transport	Wheeled carry bag

Hop-up	HU301-001-C	📏 1060(w) x 1020(h) x 360(d) mm
--------	-------------	---------------------------------

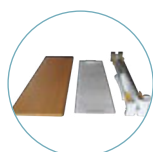

Counter components



Plastic locking arm



Carry bag included

Counter folds up with the graphic

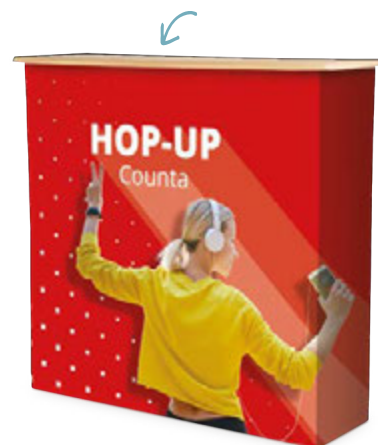

Shelf included



Modulate™ Counter



Modulate™ Counter consists of an innovative aluminium tubular frame, counter top, and printed tension fabric graphic. Powerful magnets encased inside the frame enables two or more counters to connect using simple magnetic principles. The counter can be used on its own or combined to make a long reception or bar area. Modulate™ Counter can be deployed in minutes, thanks to the tool-less construction. The printed tension fabric graphic will either sit on or under the counter-top to suit the application.

Material	Ø 30mm Aluminium tubes, MDF tabletop/shelf
Assembly	Push-fit button
Collapsible	Yes
Counter top	Black
Shelves	1 (Optional)
Load bearing	40 kg
Shelf bearing	20 kg
Graphic attachment	Zip system
Transport	Padded carry bag, internal flap

Modulate™ Counter	FORM-MOD-CNTR	⊗ 800(w) x 1015(h) x 600(d) mm
Shelf	FORM-MOD-CNTR-02	⊗ 770(w) x 9(h) x 571(d) mm



Use it on its own or combined, simply by using the integrated magnets!



Tabletop is held in place by plastic moulding underneath



Optional shelf



2 possible finishes (with or without visible shelf)



Basic Curved Counter



With a Double-D shape counter-top, the Basic Curved Counter delivers a functional and stylish look which is perfect to use for a reception desk or meeting point. The Counter is made from a rollable Corex tambour wrap to create the curved shape which push-fits into the thermoformed counter-top and base. A graphic can also be applied to the curved base to promote a message or brand. There is an opening for storage at the rear of the unit.

Material	MDF tabletop/base, Corex wrap
Assembly	Push-fit - Tool-free
Collapsible	Yes
Counter top	Beech / black
Load bearing	50 kg
Transport	2 carry bags - included

Basics Curved Counter beech/beech	PK922-BEBE	⊗ 900(w) x 926(h) x 470(d) mm
Basics Curved Counter black/beech	PK922-BLKBE	⊗ 900(w) x 926(h) x 470(d) mm
Basics Curved Counter black/white	PK922-BLKW	⊗ 900(w) x 926(h) x 470(d) mm
Shelf	PK922-SHELF-KIT	⊗ 10(w) x 853(h) x 398(d) mm



Interchangeable tabletops and bases

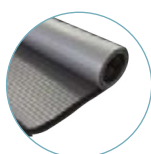

Grey counter wrap



Carry bag included



Optional shelf

Fastframe™ Counter



Complete your exhibition stand with the FASTFRAME™ counter. Quick and tool free assembly. Simply unfold the frame and secure, adding a vibrant SEG graphic for visual standout. For easy transportation, the counter is supplied in a wheeled bag.

Material	Aluminium, nylon corner, MDF tabletop/internal shelf
Assembly	Tool less
Collapsible	Yes
Counter top	Black
Shelves	Yes
Load bearing	60 kg
Shelf bearing	10 kg
Graphic attachment	Silicone Edged Graphics (SEG)
Transport	FASTFRAME™ wheeled carry bag

Fastframe Counter	FF-COUNTER-BLK	📏 1020(w) x 1025(h) x 410(d) mm
-------------------	----------------	---------------------------------



Bag



Counta



Counta is a lightweight portable indoor PVC demonstrator unit which includes a header panel, poles and shelf supporting poles. Printed graphics can be applied as vinyl directly onto the base wrap.

Available in white. Perfect for use in retail environments, one-off events and promotions.

Material	PVC
Assembly	Push-fit - Tool-free
Collapsible	Yes
Counter top	No
Shelves	1
Load bearing	20 kg
Shelf bearing	5 kg
Graphic attachment	Self-adhesive
Transport	Carry bag

Counta	PC607	📏 Counter and front graphic - 805(w) x 2195(h) x 450(d) mm
		📏 Front graphic - 680(w) x 280(h) x 20(d) mm

Carrying bag included



Shelf for storage



Promotional counter, ideal for a retail



Formulate Oval Counter



Lightweight but robust Formulate counter, ideal for promotional or exhibition applications. Display your message at 360° angle with optional washable tension fabric graphic.

Material	Ø30 mm aluminium tubes, MDF tabletop/base
Assembly	Tool-free
Collapsible	No
Counter top	Black
Load bearing	50 kg
Graphic attachment	Silicone Edged Graphics (SEG)
Transport	Carry bag with internal flap

Formulate Oval Counter	FORM-OVAL-CNTR	☏ 565(w x 1020(h)) x 397(d) mm
------------------------	----------------	---------------------------------



Silicone Edged Graphics (SEG)



Load bearing maximum: 50kg



illuminated Promotional Counters

Illumigo™ Counter



This versatile and quick to set-up double-sided counter lightbox is a great all-rounder not only at events but in retail environments from shopping centres to pop-up shops. Part of the Illumigo™ range, the Illumigo™ Counter is easy to assemble with a two-part counter top that secures using a pair of twist out top locators and locking screws. Building the unit is intuitive and tool-free as all the parts are numbered and simply slot together. Two optional graphics complete the look to create an impactful counter ideal for attracting attention in retail, event or exhibition environments.

Material	Aluminium 100 mm, MDF table top
Assembly	Tool-free
Collapsible	Yes
Counter top	White
Load bearing	20 kg
Graphic attachment	Silicone Edged Graphics (SEG)
Transport	Protective box with carry handle
LED System	LED strips included

Illumigo™	ILLGO-COUNTER	1040(w x 1045(h)) x 420(d) mm
Illumigo™ Bag	ILLGO-BAG	460(w) x 1160(h) x 190(d) mm



Optional Illumigo™ bag



Protective compartmented box



Pre-assembled LEDs in the frame

Steel side feet for stability



Insta LED Counter



Attract attention with the Insta LED counter! This illuminated counter with automatic scissor lift system and pre-assembled LED strips can be set up in no time at all and will be perfect for enhancing all your indoor events.

Material	Steel scissor lift, aluminium mounting bracket, MDF tabletop/base
Assembly	Tool-free
Collapsible	Yes
Counter top	Black
Load bearing	30 kg
Shelves	No
Graphic attachment	Silicone Edged Graphics (SEG)
Transport	Carry bag

Insta LED Counter	INSTA-CNTR-BLK	782 w) x 1015(h) x 398(d) mm
-------------------	----------------	------------------------------



LED lights



Protective compartmented bag

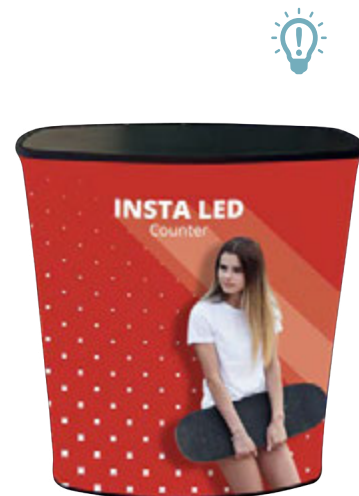



Barrier systems improve queue management and help with crowd control.

For pedestrian control, café barriers can be used to make an attractive, professional and functional barrier, creating a temporary space that can be easily reconfigured to suit your needs.

Café barriers are easy to store, assemble, deploy and move to suit your requirements. They are available in economy and premium solutions, depending on your application and budget.



Barriers

Queue management systems can be used to control queues, providing structured and manageable lanes to help marshal customers and are also suitable for indoor or outdoor use.

Pedestrian control barriers

A cost-effective way of defining areas outside restaurants, bars, shopping centre and coffee shops, a complete Café Barrier system requires two posts and bases. To secure the graphic, there are two options; dependent on budget and where the system is being deployed.

If the Café Barrier is exposed to strong winds, we recommend a two-rail option ensuring the graphic is secured top and bottom to each post and base. If winds are not an issue but the budget is tight, then we suggest a single rail with two spring clips securing the bottom of the graphic.

Rails are available in 1m, 1.5m and 2m sizes, so it is quick and easy to calculate the number of café barriers required to define your space. To connect multiple barriers, add a choice of rails/spring clips plus one additional pole and base. For vibrant hardwearing graphics we can print on PVC.

Economy Café



Material	Aluminium
Graphic area	Double-sided / or single-sided
Graphic attachment	Looped top rail. Looped bottom rail or spring clips
Weight	9.13 kg



Graphic rail 1000 mm	UB214-1000	⌀ 1140(w) x 25(h) mm
Graphic rail 1500 mm	UB214-1500	⌀ 1940(w) x 25(h) mm
Graphic rail 2000 mm	UB214-2000	⌀ 2440(w) x 25(h) mm
Base	UB214B	⌀ 355 (Ø) mm
Post	UB214P	⌀ 960(h) mm
Spring clips (pair)	UB214-SC	

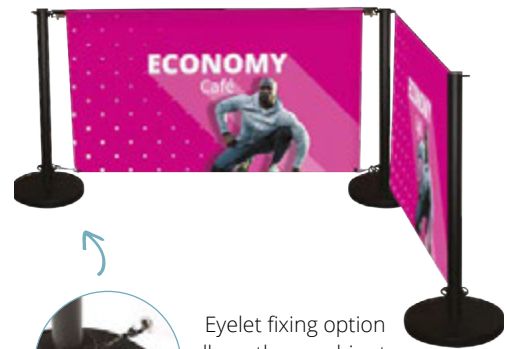

Eyelet fixing option allows the graphics to follow the movements of the wind



Spring clips for securing eyelet graphic



Graphic rail



Base and post

Deluxe Café



Material	Aluminium chrome look finish
Graphic area	Single / double-sided
Graphic attachment	Looped top rail. Looped bottom rail or spring clips
Weight	8.63 kg



Graphic rail 1000 mm	UB215-1000	⌀ 1140(w) mm
Graphic rail 1500 mm	UB215-1500	⌀ 1940(w) mm
Graphic rail 2000 mm	UB215-2000	⌀ 2440(w) mm
Base	UB215B	⌀ 355 (Ø) mm
Post	UB215P	⌀ 960(h) mm
Spring clips (pair)	UB215-SC	





 **DELUXE**
Café

 **DELUXE**
Café

The range of ancillary products include literature holders, lighting solutions for various hardware ranges and transportation cases.

These ancillaries offer flexibility and perfectly complement our product solutions.

Ancillaries

Enhance an exhibition stand by selecting various supporting products from our range of ancillaries that are often used to help promote your brand in a more impactful way, professionally display your latest literature, or add points of interest, making your stand more visible by using spot lights.

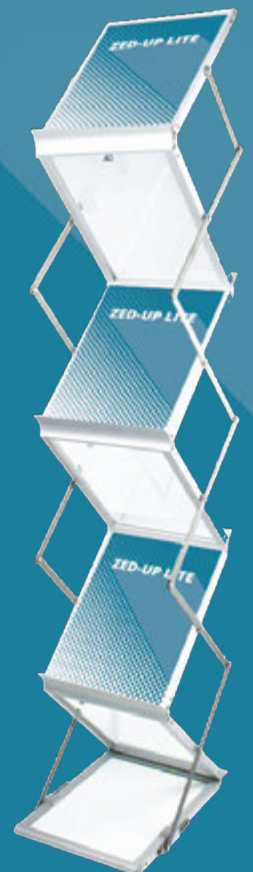

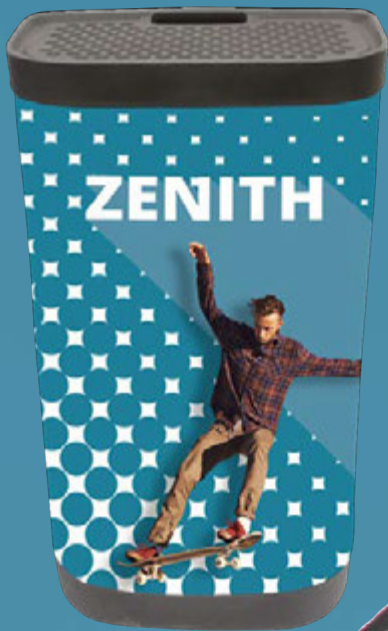

Literature holders

Zed-Up Lite



Zed-Up Lite are a popular range of aluminium literature stands that are stylish and highly portable. Quick and easy to deploy, Zed-Up Lite is ideal for exhibitions and displays, folding down for easy transportation in a heavy duty hard case.

Material	Acrylic and anodised aluminium
Colour	Silver
Documents sizes	A4
Pockets	6
Double-sided	Yes
Transport	Hard case (included)

A4 (6 pockets)	AS315-002	256(w) x 1460(h) x 370(d) mm
----------------	-----------	------------------------------



Rigid carry case included



Lighting (standard)

Powerspot 950/1000 LED



Economical black LED spotlight particularly suitable for use with Pop-up stands.

Material	Aluminium and plastic
Positioning	270° - Straight arm
Watt output	12 watt (1400 Lumens/5500 Kelvins)
Watt consumption	12 Watt (1400 Lumens/5500 Kelvins)
Linked lights	2 max
Double kit includes	2 spotlights + 2.5m linking lead + 1 transformer
Power lead UK & Euro	Yes (cross head screwdriver needed)



Double kit	PS950-1000-LED-BDLK	Ⓞ, 103(w) x 425(h) x 29(d) mm
------------	---------------------	-------------------------------



Transformer included

Connect up to 5 lights with one transformer

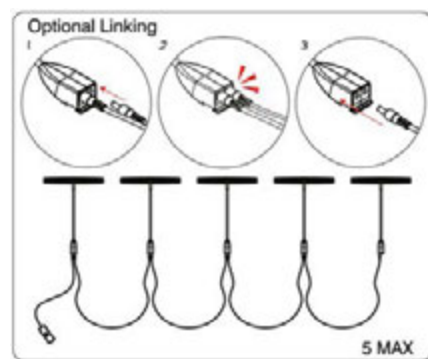

Lighting (premium)

LED Floodlight



The LED Floodlight is the new stylish and economical way to illuminate a range of exhibition stands including Pop-ups, Formulate and a range of modular systems. Despite the compact design, this small LED light is still capable of producing 1200 Lumens but still only consuming a small amount of energy, making it far more efficient than the halogen equivalents. Link up to 5 lights together from one transformer, with handy linking cables.

Material	Aluminium and plastic
Watt output	80 watt
Watt consumption	12 watt (1200 Lumens/5631 Kelvin)
Linked lights	Link up to five to one transformer
Double kit includes	2 spotlights + 2.5m linking lead + 1 transformer
Power lead UK & Euro	Yes (cross head screwdriver needed)

Swivel head



Double kit	LED-FLOOD-ARM-BDLK	Ⓞ, 295(w) x 483(h) x 60(d) mm
------------	--------------------	-------------------------------

Connect up to 5 lights with one transformer

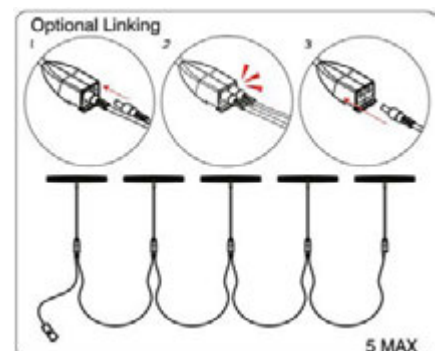

Transportation box



Transformer included

LED Strip Light



The LED Strip light is designed to work with a wide range of exhibition stands including, Pop-ups, Formulate and a range of modular stands. It has a unique wide head design feature, allowing for a wider spread of light, helping you illuminate more of your message. Link up to 5 lights together from one transformer, with handy linking cables.

Material	Aluminium and plastic
Watt output	80 watt
Watt consumption	12 watt (1200 Lumens/5631 Kelvin)
Linked lights	Link up to five to one transformer
Double kit includes	2 spotlights + 2.5m linking lead + 1 transformer
Power lead UK & Euro	Yes (cross head screwdriver needed)



Swivel head

Double kit	LED-STRIP-ARM-BDLK	Ⓜ 100(w) x 520(h) x 35(d) mm
------------	--------------------	------------------------------



Transportation box



Transformer included

Connect up to 5 lights with one transformer

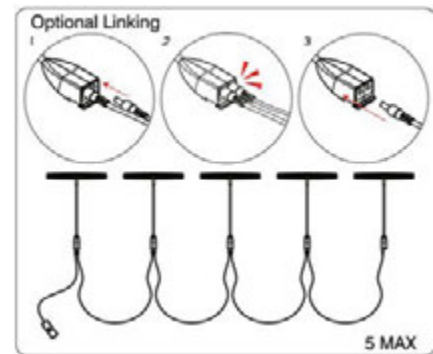

LED Exhibition Light



Specifically designed to work in conjunction with the Vector channel; this latest design requires no extra fitting, just plug in and switch on. Not only does the slick design make the LED Exhibition Light stand out from the crowd, the clever design cast out of aluminium allows any heat to dissipate over the entire body of the light, stopping any localised heat, which allows for long use with no overheating. Link up to 5 lights together from one transformer, with handy linking cables.

Material	Aluminium and plastic
Watt output	80 watt
Watt consumption	12 watt (1200 Lumens/5631 Kelvin)
Linked lights	Link up to five to one transformer
Double kit includes	2 spotlights + 2.5m linking lead + 1 transformer
Power lead UK & Euro	Yes (cross head screwdriver needed)



Ideal for modular stands

Double kit	LED-EXHIB-ARM-BDLK	Ⓜ 50(w) x 455(h) x 55(d) mm
------------	--------------------	-----------------------------



Transportation box







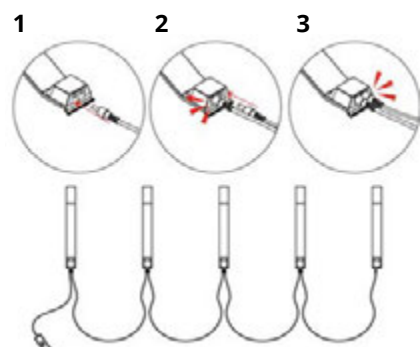

Transformer included

Connect up to 5 lights with one transformer



Lighting ancillaries

Recommended fixings for lighting

Integrated fixing			
	Universal fixing kit US901-C	Vector fitting VLF	30mm Ø Tube clamp US903
Compatible with :			
 Spot LED Flood LED-FLOOD-ARM-BDLK	> Quick +	> Arena	> Vector > Fastframe
 Spot LED Strip LED-STRIP-ARM-BDLK	> Quick +	> Arena	> Vector > Fastframe
 Spot LED Exhibition LED-EXHIB-ARM-BDLK	> Linear > Vector > Fastframe	/	> Formulate > Modulate™
 Powerspot 950-1000 LED PS950-1000-LED-BDLK	> Quick Impact > Quick + > Hop-up	> Arena	> Vector > Fastframe™

Convert your UK plug into EU version



Unscrew



Lift the lid



Pull the plug to extract it

Portable transportation cases

Zenith



Tough moulded polyethylene Zenith case offers a multitude of features. Versatile ultra-portable transport solution with maximum storage for pop-ups, backwalls, roller banners and extrusions, they also double up as counters with optional extra graphic wrap and table top. The standard case will house a 3x5 pop-up system and graphics. Secure Internal dividers protect graphics and the case can be locked using padlocks (not supplied).

Material	Medium-density polyethylene (MDPE) / Metal
Wheels	2
Handle	1
Accessories	Beech table top / graphic wrap

Zenith	AC600	(External dimensions) 600(w) x 956(h) x 400(d) mm
Tabletop (beech)	CO401-C	15(h) x 640 (l) x 420 (p) mm



Zenith case thermoformed tabletop in beech



Foam protected lid holds two LED lights



Graphic wrap (optional)



956 mm

With wheels for easy transportation

Fastframe™ Wheeled Bag



This padded wheeled bag can hold up to four FastFrame hardware pieces within a 1200mm width.

Material	Nylon
Colour	Black
Wheels	Yes
Handle	1

Wheeled Bag	FF-WB	1415(w) x 390(h) x 244(d) mm
-------------	-------	------------------------------

* Can accommodate up to 4x 1200x2400 fastframe hardware and graphics.



Carry handle



Wheels ø50mm



Illumigo™ Bag



Wheeled bag for Illumigo™ Retail, ONE or the Illumigo™ Counter.

Material	Nylon and inner MDF
Colour	Black
Wheels	Yes
Handle	2

Illumigo™ bag	ILLGO-BAG	Ⓞ (Internal dimensions) 460(w) x 1160(h) x 190(d) mm
---------------	-----------	--



Wheeled bag



Inner compartment for graphic



Carry handle

Modular carrying bag



Ideal wheeled bag for transporting, protecting and storing exhibition stands, especially those made from standard modules (Vector & Formulate).

Material	Nylon
Colour	Black
Wheels	Yes
Handle	2

Modular Bag	AB-MODULAR-01	Ⓞ 340(w) x 1400(h) x 290(d) mm
-------------	---------------	--------------------------------



Carry handle



Wheels ø40mm



With graphic storage





A

Ancillaries	55
Android Freestanding Digital Poster	126
Android PCAP Touch Screen Kiosks	127
Arena	76
Arena components	77
Arena Custom Stand 16m ²	78
Arena Custom Stand 36m ²	78
Arena Custom Structure	79
Arena Gantry free-standing design	79
Arena Gantry stand designs	78
Arena Hanging Structure	79
Arena Junction Sections	77
Arena Straight Sections	77
A-sign Board	114

B

Barracuda	101
Baseline Jumbo Panel Kits	121
Baseline Panel Ancillaries	122
Baseline Panel and Pole Kits	118
Baseline Panel Folding Kits	120
Baseline Panels – Customisable and Versatile Display Solutions	122
Baseline Tabletop Panel Kits	119
Baseline Wheeled Panel Kits	121
Basic Curved Counter	147
Beijing Lite	107
Blizzard	107
Bora Tent	143
Breeze	106

C

Counta	148
--------	-----

D

Delta Lite	100
Deluxe Café	154
Digital screens	126
Display Boards	118
Dragonfly 2	99

E

Economy Café	154
--------------	-----

F

Fabric tube walls	91
Fastframe™	57
Fastframe™ 2-Way Connector - Single	67
Fastframe™ 4-Way Connector - Single	67
Fastframe™ 45° Connector Kit - Top & Bottom	65
Fastframe™ 90° Connector Kit - Top & Bottom	65
Fastframe™ 90° Left Inside Connector Kit - Pair	66
Fastframe™ 90° Middle Connector Kit - Pair	66
Fastframe™ 90° Right Inside Connector Kit - Pair	66
Fastframe™ 950x2000	61, 103
Fastframe™ 950x2400	61, 103
Fastframe™ 950x2500	62, 104
Fastframe™ 1000x500 - 2 Pack	60, 102
Fastframe™ 1000x1000 - 2 Pack	60, 102
Fastframe™ 1000x2000	62, 104
Fastframe™ 1000x2400	63, 105
Fastframe™ 1000x2500	63, 105
Fastframe™ 1200x2400	64, 106
Fastframe™ Arch Brace Kit	68
Fastframe™ Arch Connector Kit - 4 Brackets	66

Fastframe™ Backwall Kit - 2 Metre	89
Fastframe™ Backwall Kit - 3 Metre	90
Fastframe™ Connectors	65
Fastframe™ Counter	148
Fastframe™ Cross Connector Kit - Top & Bottom	66
Fastframe™ Door Mount Bracket Kit	68
Fastframe™ Feet	65
Fastframe™ Full Foot (Single)	65
Fastframe™ Half Middle Foot (Single)	65
Fastframe™ Kits	68
Fastframe™ Middle Full Foot (Single)	65
Fastframe™ Pop-up Kit	89
Fastframe™ Screen Mount Kit	68
Fastframe™ Shelf Kit	68
Fastframe™ Side Half Feet (Pair)	65
Fastframe™ Small Middle Foot (Single)	65
Fastframe™ Stand 6m ²	69
Fastframe™ Stand 9m ²	70
Fastframe™ Stand 12m ²	71
Fastframe™ Stand 15m ²	72
Fastframe™ Stand 18m ²	73
Fastframe™ Stand 24m ²	74
Fastframe™ T-Shape Connector Kit - Top & Bottom	66
Fastframe™ Wheeled Bag	162
Fastframe™ Y Shape Connector Kit - Top & Bottom	66
Formulate Circular Hanging Structure	80
Formulate Flat Panel Hanging Structure	81
Formulate Horizontal Curve	92
Formulate LED Backwall	91
Formulate Monolith	108
Formulate Monolith Eco	108
Formulate Oval Counter	149
Formulate Rectangular Hanging Structure	81
Formulate Round Table	116
Formulate Shadow	114
Formulate Square Hanging Structure	80
Formulate Straight	91
Free-standing flag bases	134
Free-standing flags	132
Free-standing signs	112

G

Grasshopper	98
-------------	----

H

Hanging structures	80
High Brightness Outdoor Digital Battery A-Boards	129
Hop-up Counta	146
Hop-up Impact Curved	88
Hop-up Impact Straight	88
Horizon	92

I

Illumigo™ 2x2	18
Illumigo™ Bag	163
Illumigo™ Counter	18, 150
Illumigo™ Lite Mag	16
Illumigo™ Modular	15
Illumigo™ One	17
illuminated Promotional Counters	150
Illuminova™ Modules	40
Impact Pop-up Curved	85
Impact Pop-up Curved Bundle	85
Impact Pop-up Straight	84
Impact Pop-up Straight Bundle	84
Inflatable tents	143
Insta LED Counter	150

L

LED Exhibition Light	160
LED Floodlight	159
LED Strip Light	160
Lighting ancillaries	161
Lighting (premium)	159
Lighting (standard)	159
Literature holders	158

M

MagLink	23
Mantis	97
Merlin	101
Mistral	136
Mobile flags	137
Modular carrying bag	163
Modulate™	23
Modulate™ ancillaries	29
Modulate™ Counter	147
Modulate™ Slope	28
Modulate™ Stand 6m2	30
Modulate™ Stand 9m2	31
Modulate™ Stand 12m2	32
Modulate™ Stand 15m2	33
Modulate™ Stand 18m2	34
Modulate™ Stand 24m2	35
Modulate™ Straight	26
Modules Vector - Arches	41
Monsoon	115
Mosquito	98

N

Network Digital Boards	129
------------------------	-----

O

Orient +	99
Outdoor Table	116

P

Parasol	143
Pedestrian control barriers	154
Pegasus	93
Pegasus 3m	93
Pop-up backwalls	84
Pop-up Counta	146
Pop-up tents	140
Portable transportation cases	162
Post Module	41
Post / wall mounted flags	136
Powerspot 950/1000 LED	159
Promotional counters	146

Q

Quick+ Curved Bundle	87
Quick+ Curved Kit	86
Quick+ Straight Bundle	87
Quick+ Straight Kit	86
QuickLink	4

R

Recommended fixings for lighting	161
Roller Banner comparison guide	96
Roller banners (economy)	97
Roller banners (premium)	101
Roller banners (standard)	99

S

Sentry	112
Slimline Pro Advertising Displays	126
Stowaway	115
Street Flag	137
Superslim Freestanding Double-Sided	
Digital Posters	127
Suspended signs	117
Symbol	113

T

Tabletop Displays	106
Tension banners (X Banner)	107
Tension textile systems	108
Tension walls	92
Thunder 2	100
Trappa Frame	117
Twista Lite	117

U

Ultra-Wide Stretched Bar Displays	128
-----------------------------------	-----

V

Vector 36	
Vector Custom Stand 24m2	50
Vector Custom Stand 40m2	50, 51
Vector Custom Stand 60m2 - Design 1	52
Vector Custom Stand 60m2 - Design 2	52
Vector Custom Stand 80m2	53
Vector Media	109
Vector Modules ancillaries	54
Vector Modules Extensions	42
Vector Modules - Storage	42
Vector Modules - Walls	38
Vector Stand 6m2	43
Vector Stand 9m2	44
Vector Stand 12m2	45
Vector Stand 15m2	46
Vector Stand 18m2	47
Vector Stand 24m2	48

W

Wall mounted signs	117
Wasp	97
Wedge	112
Whirlwind	113
Wind Dancer	135
Windows PCAP Touch Screen Kiosks	128

Z

Zed-Up Lite	158
Zenith	162
Zoom+ Arch	135
Zoom+ Edge Flag	133
Zoom+ Quill / Feather / Crest Flag	132
Zoom Parasol	143
Zoom Tent	141
Zoom Tent 3x3 Sky Banner	141
Zoom Tent Eco	140

DISPLAY 20

HANDBOOK **26**