

# Pop Up Modular



**ABC EXPO .BE**

Portable and folding displays and stands  
Layout, graphics, photography and digital printing



# PopUp Modular

ideaal om zelf je gepersonaliseerde stand te bouwen. De configuratie kan je steeds zelf aanpassen!



- geen gereedschap
- compact en zeer licht
- makkelijk voor transport
- snel op te bouwen
- PopUp frame
- Textiel print met silicone pees



# MODU 100

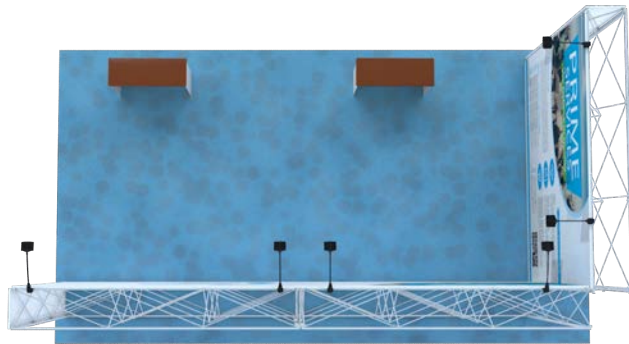
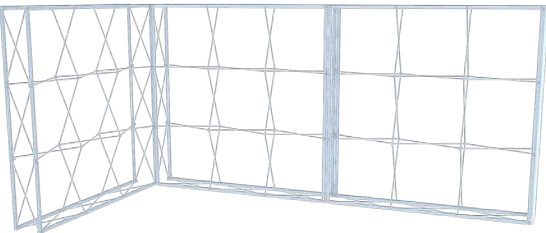

# MODU 101

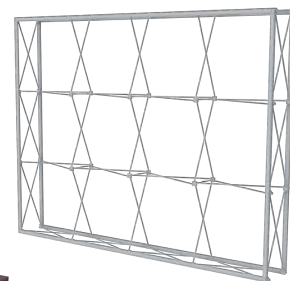

## MODU 102

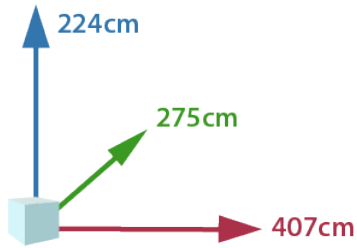
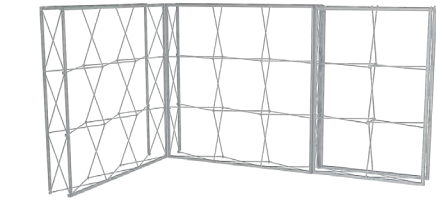

x 3 transport tassen



snel geïnstaleerd

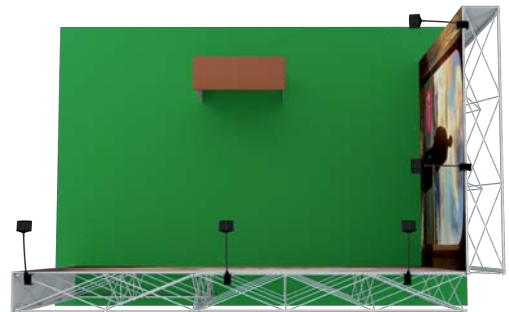

## MODU 103

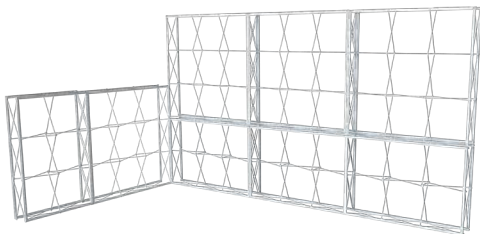
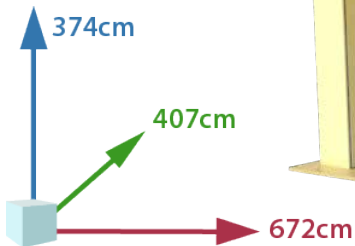

x 8 transport tassen



snel geïnstaleerd



MODU 104



- x 5 transport tassen
- snel geïnstalleerd

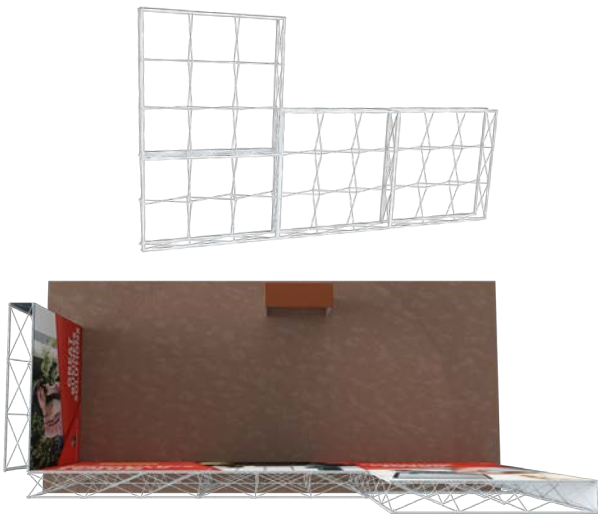

MODU 105

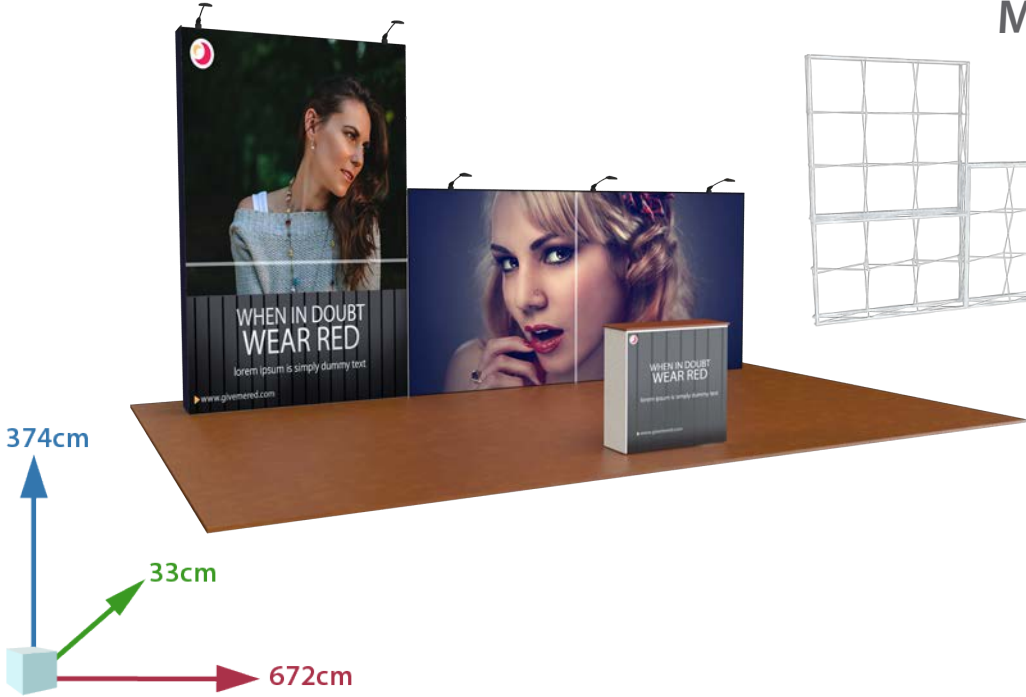

- x 4 transport tassen
- snel geïnstalleerd



# MODU 106

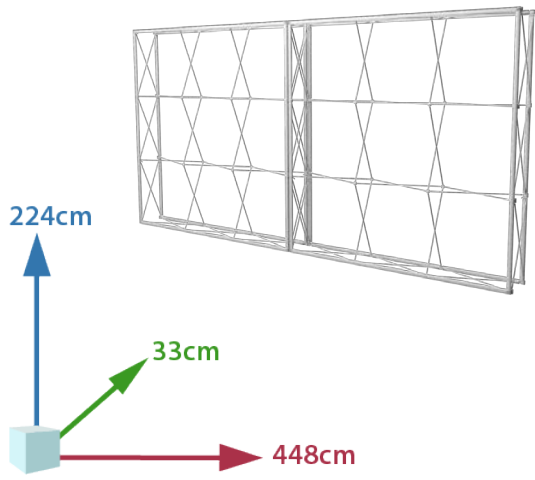

x 2 transport tassen



snel geïnstaleerd



# MODU 107

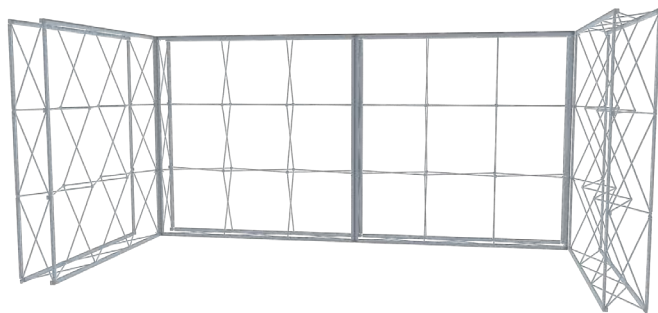
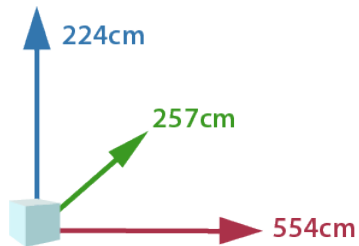

x 4 transport tassen



snel geïnstaleerd



## MODU 108

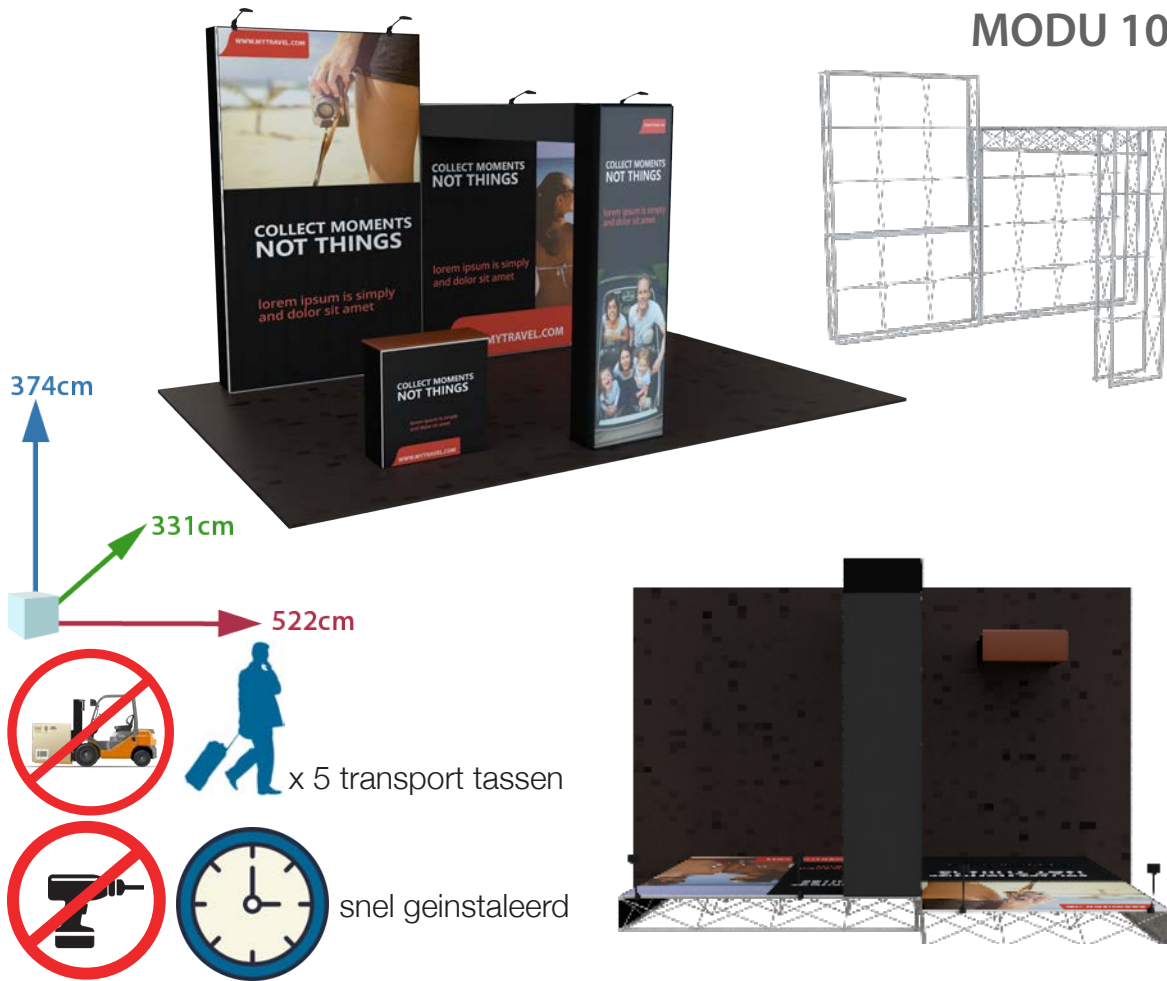

## MODU 109



## MODU 110



## MODU 111

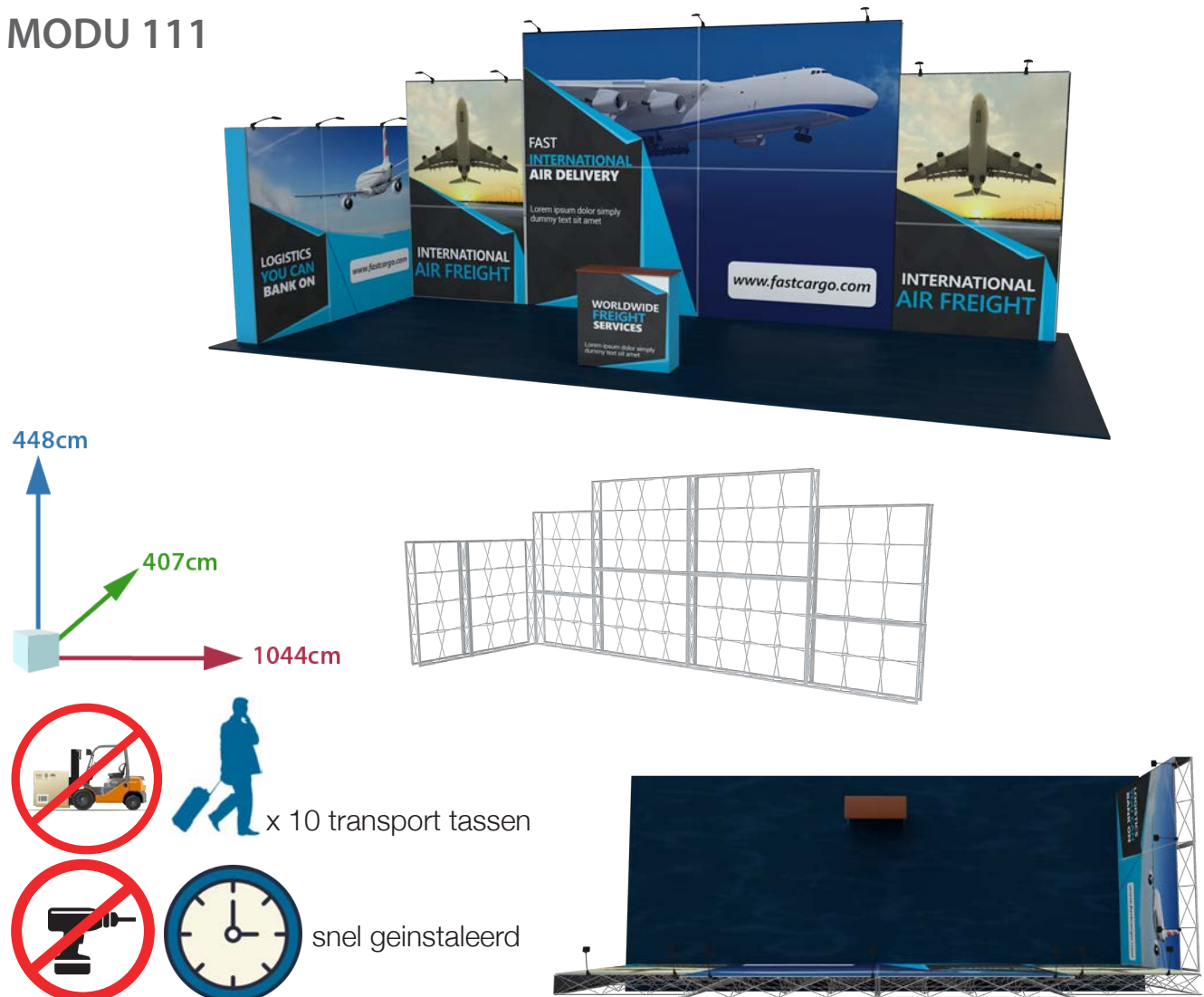

## MODU 112

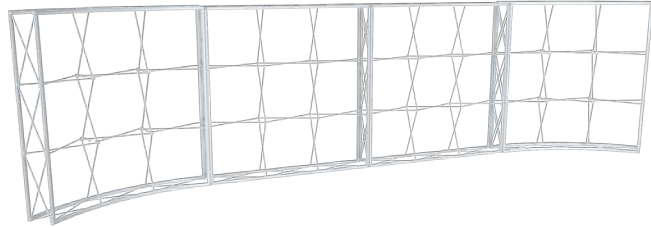
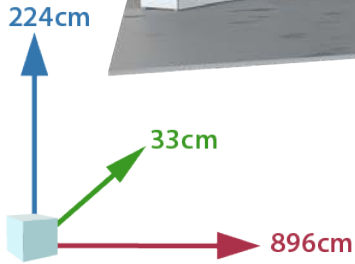

## MODU 113

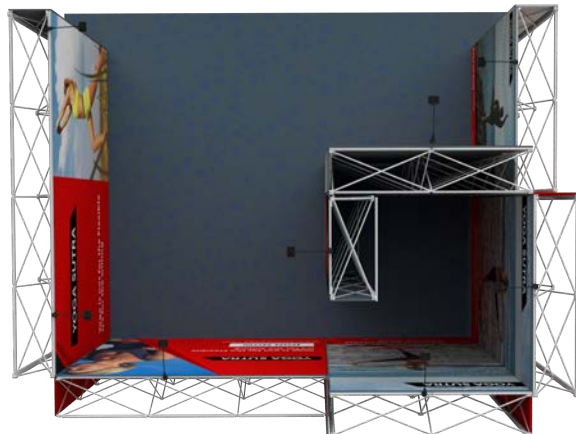
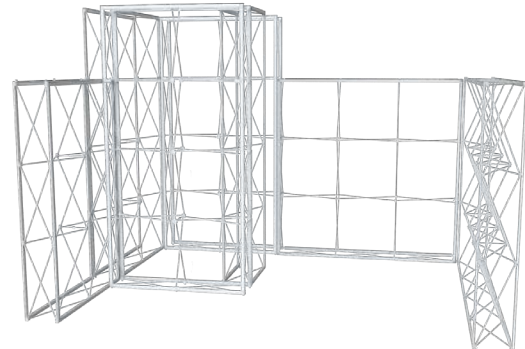
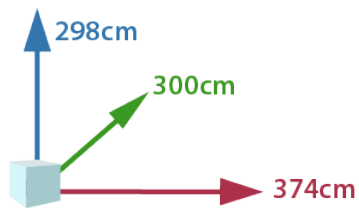

# MODU 114



224cm



33cm



1192cm

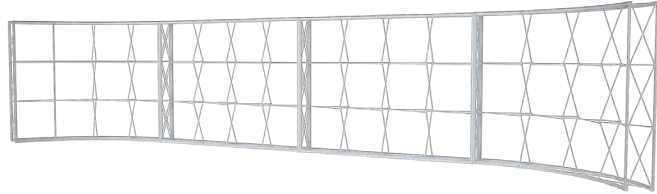

x 4 transport tassen



snel geïnstalleerd

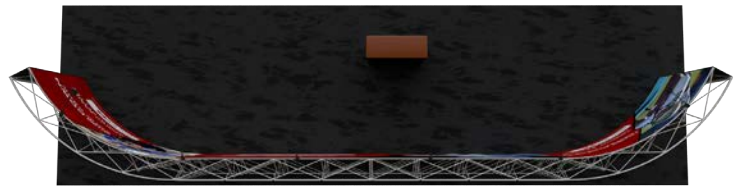

# MODU 115



298cm



58,5cm



838cm

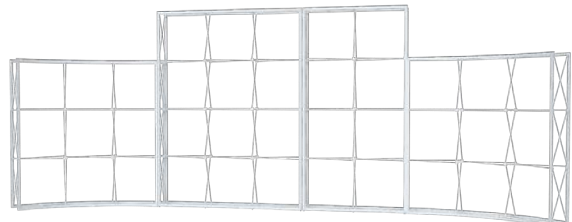

x 4 transport tassen



snel geïnstalleerd



# MODU 116

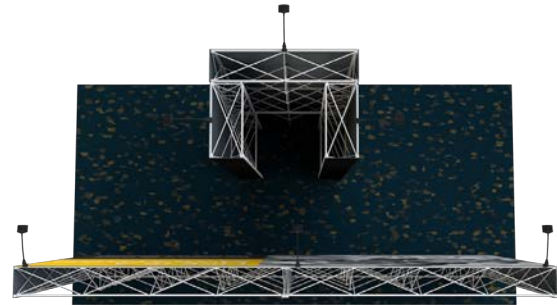

# MODU 117

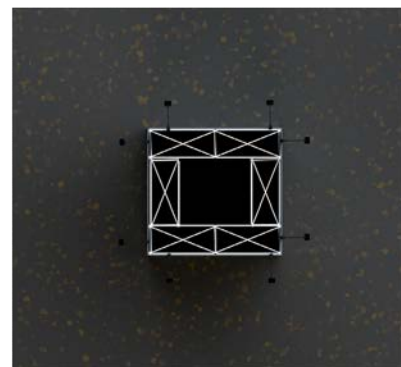

# MODU 118

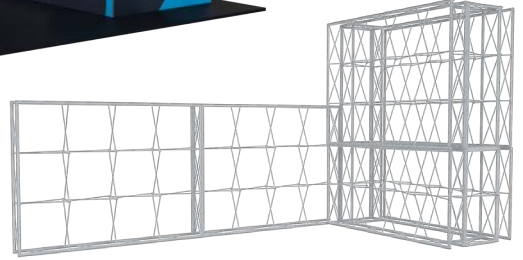
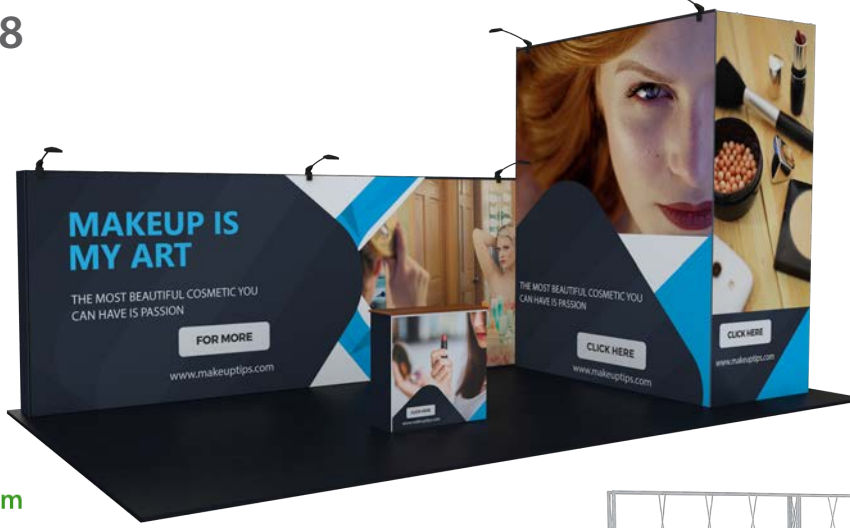
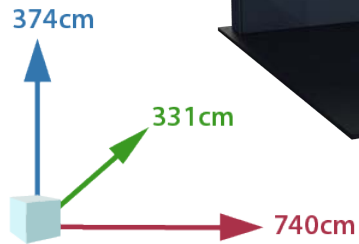

# MODU 119

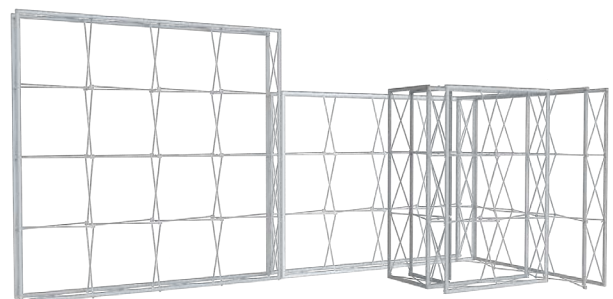
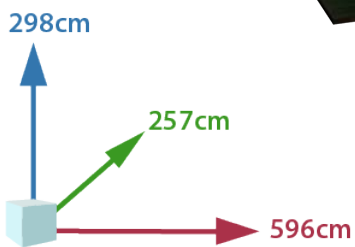

## MODU 120

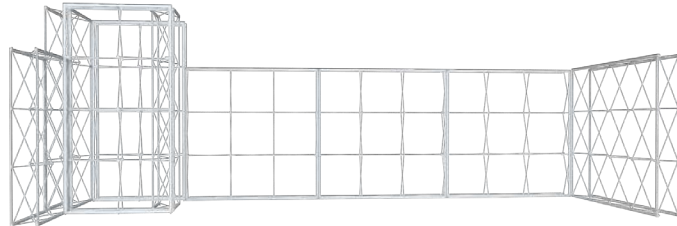
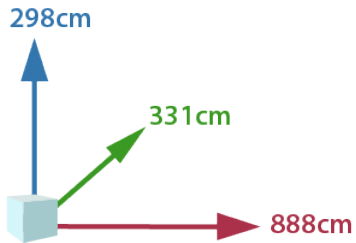

x 10 transport tassen



snel geïnstalleerd



## MODU 121

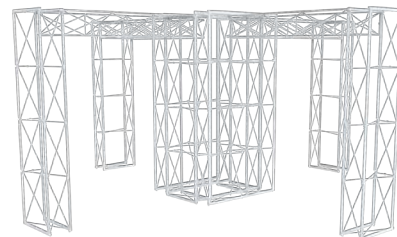
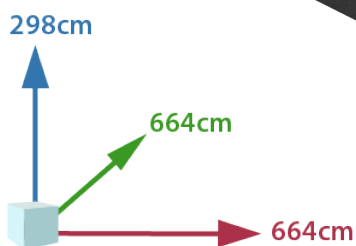

x 12 transport tassen



snel geïnstalleerd

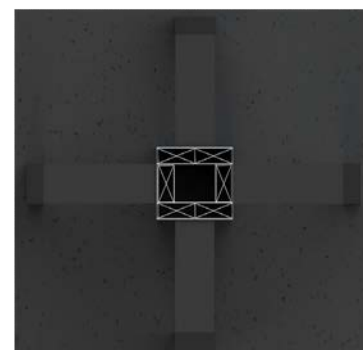

## MODU 122

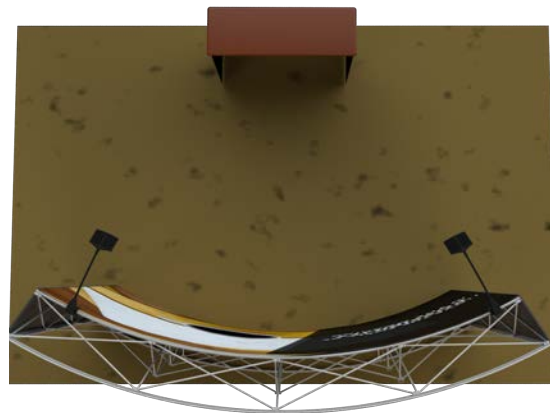
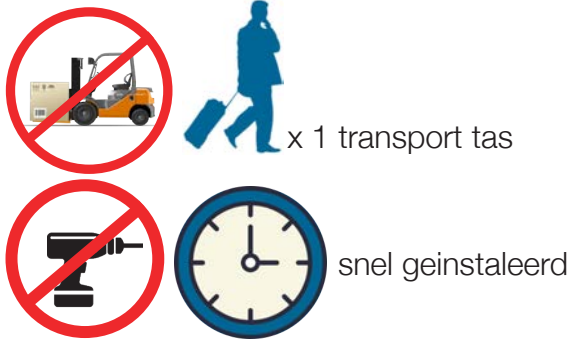

## MODU 123

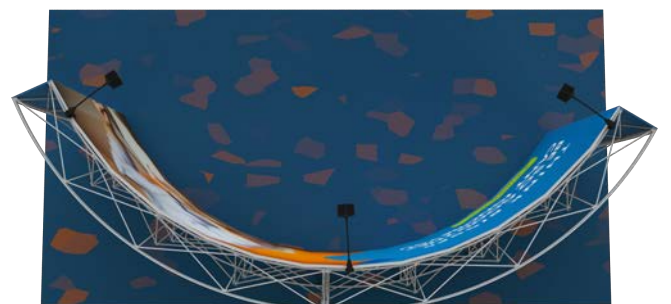
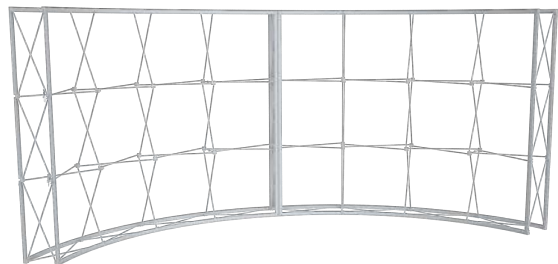

# MODU 124

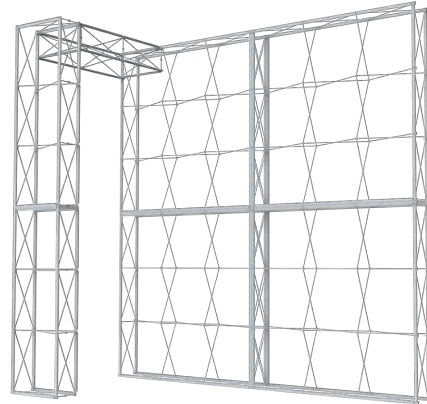
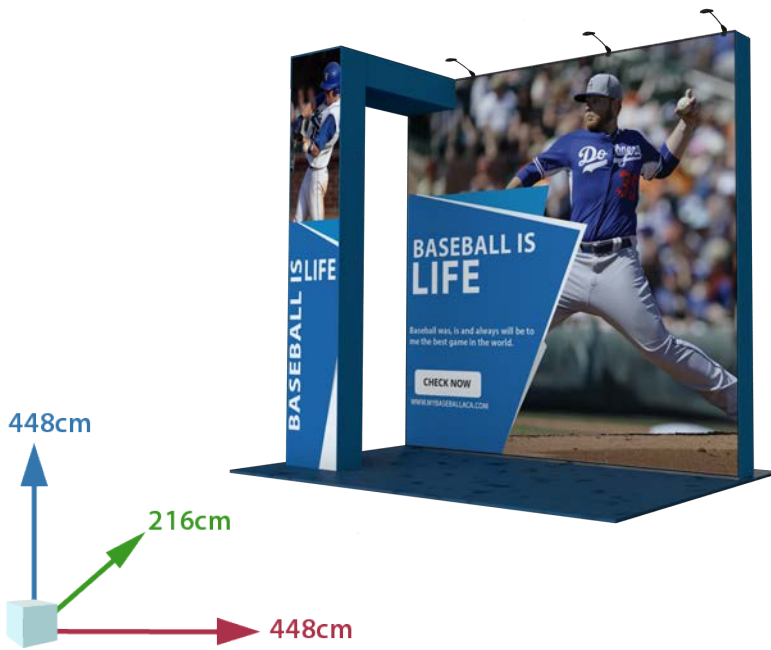

## MODULAR LED COUNTER

## MODULAR FABRIC COUNTER

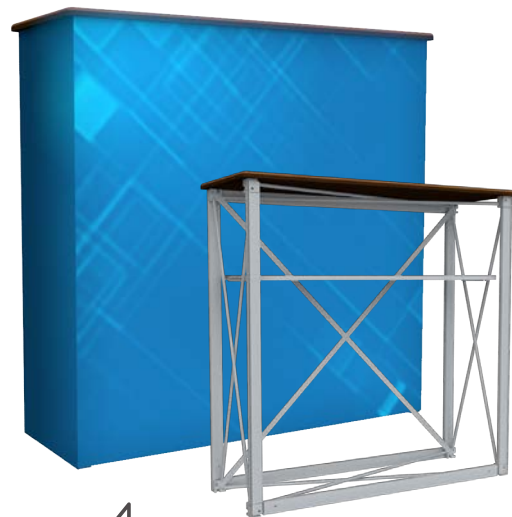
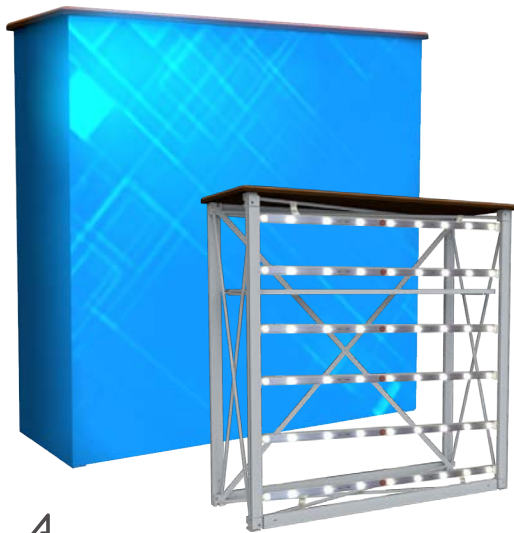

#2401: 100x100cm



#2402: 100x100cm



1 pc. per carton  
1 Stk. im Karton  
1 pc par carton  
1st per doos



guaranteed quality  
Qualitätsgarantie  
qualité garantie  
Kwaliteitsgarantie

## MODULES STRAIGHT

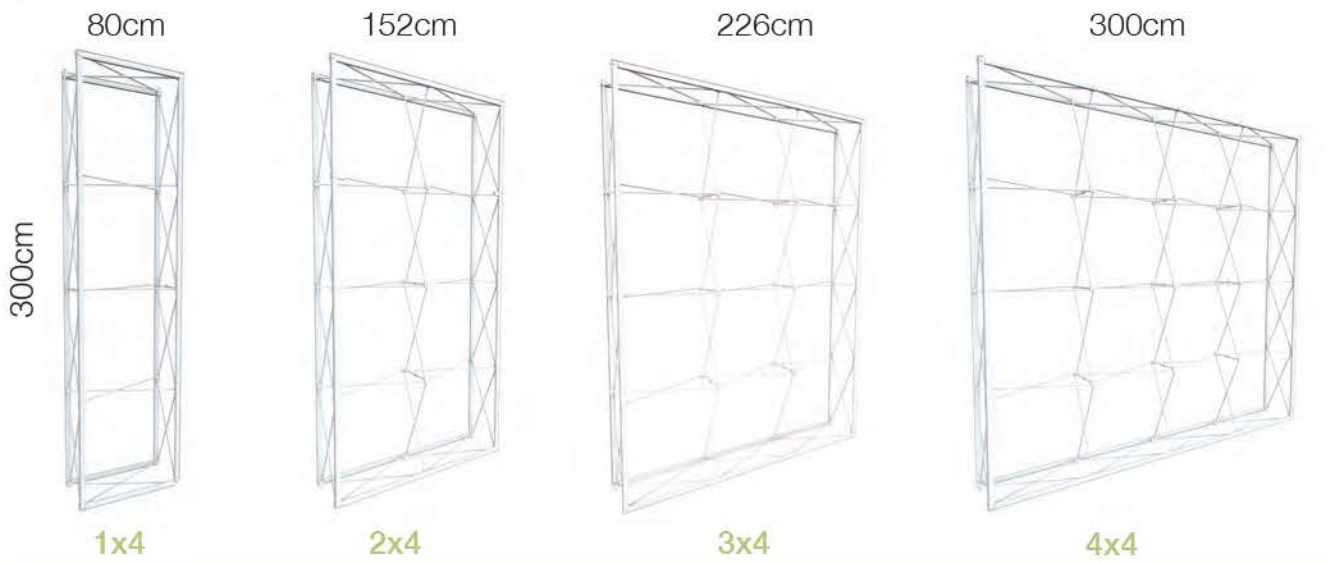
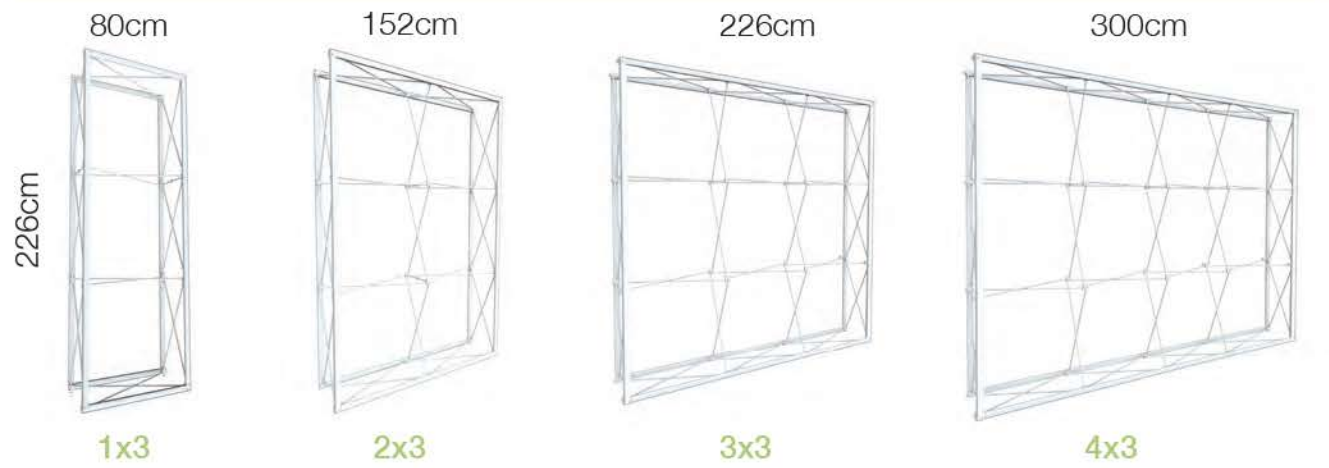
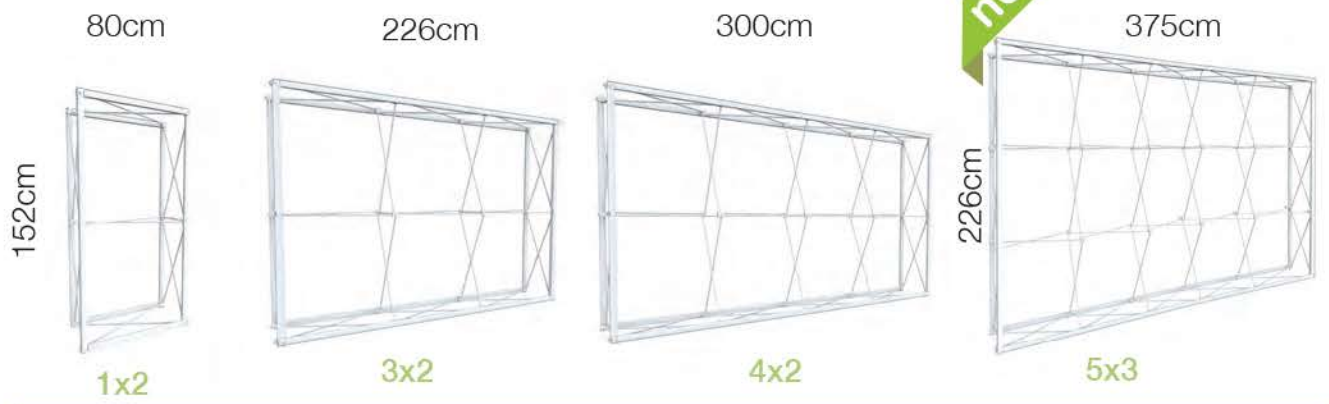

## MODULES CURVED

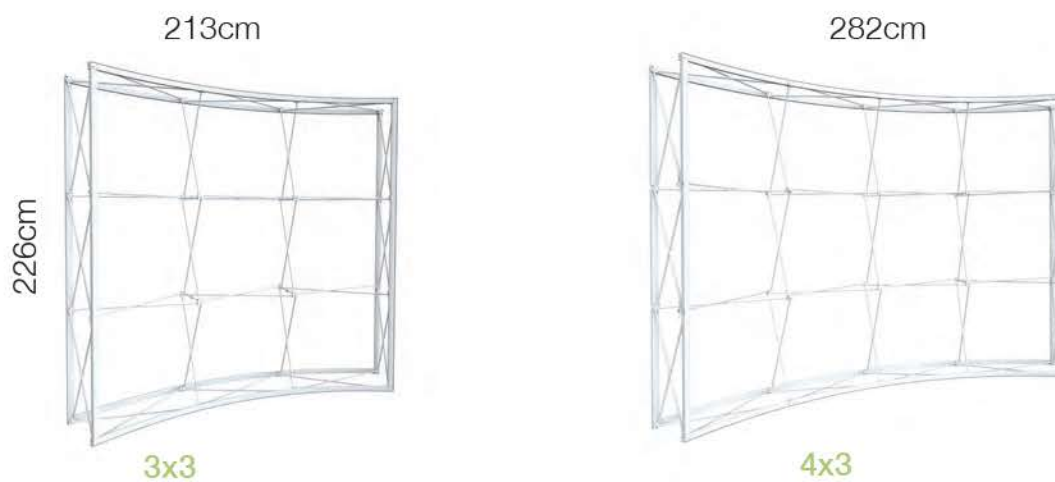

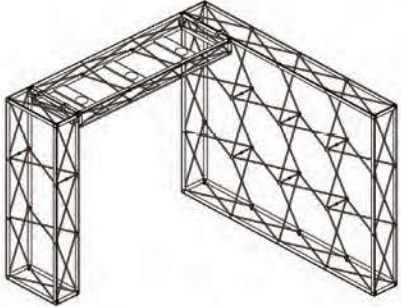

LED Kit for Bridge  
9 Watt

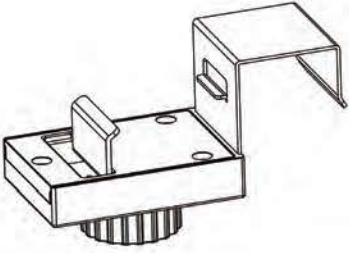
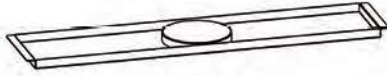

Bridge hook connector

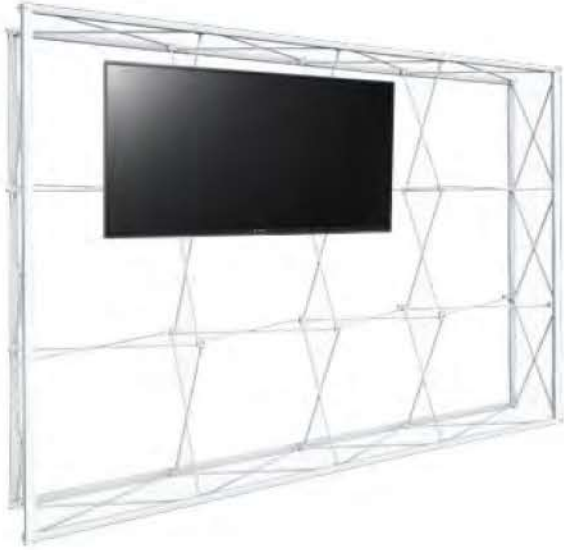
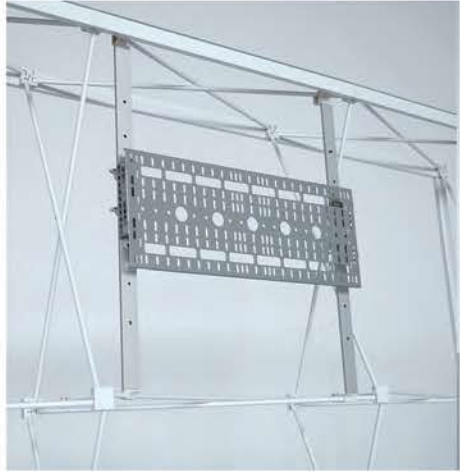
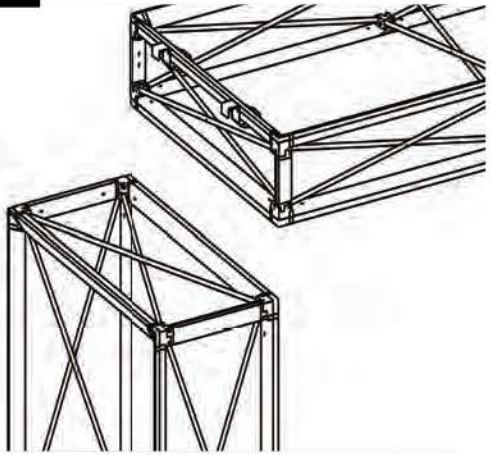

TV Bracket

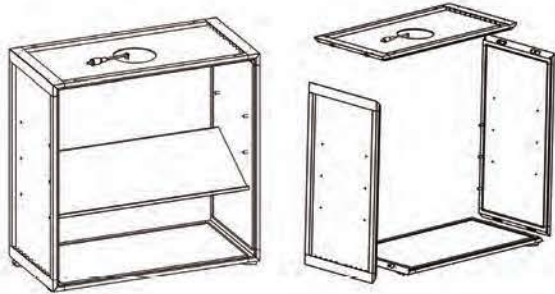

*showcase*

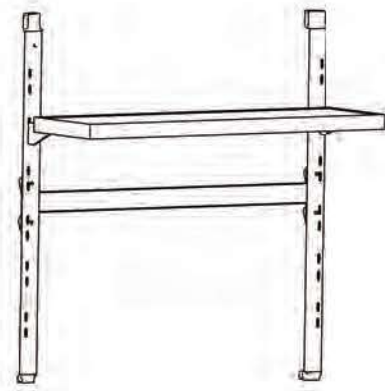
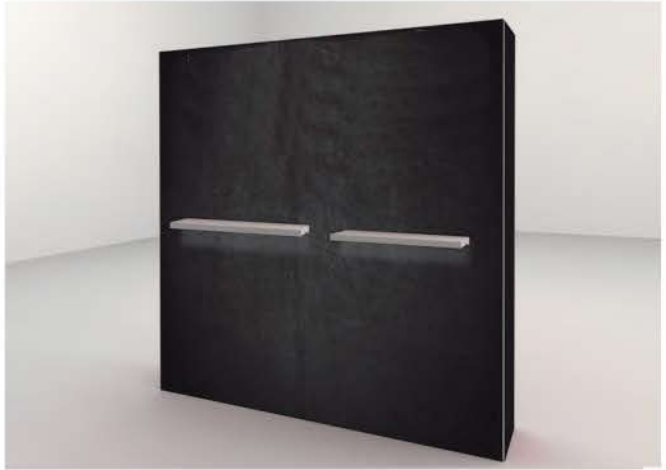

*External shelf*

